

# *CSL Series*

## *Digital Counting Scale*

### Operation Manual

Revision 1.0  
July 17, 1998

***Transcell Technology inc.***

© 1998 Transcell Technology, Inc.

Contents subject to change without notice.

Transcell Technology, Inc.  
975 Deerfield Parkway  
Buffalo Grove, IL 60089  
Tel (847) 419-9180  
Fax (847) 419-1515

## **NOTE**

This equipment has been tested and found to comply with the limits for a Class A digital device, pursuant to Part 15 of the FCC Rules. These limits are designed to provide reasonable protection against harmful interference when the equipment is operated in a commercial environment. This equipment generates, uses and can radiate radio frequency energy and, if not installed and used in accordance with the instructions manual, may cause harmful interference to radio communications. Operation of this equipment in a residential area is likely to cause harmful interference in which case the user will be required to correct the interference at his/her own expense.

# TABLE OF CONTENTS

	<u>Page</u>
Chapter 1: Introduction to the Transcell CSL Series Digital Counting Scale.....	1-1
Chapter 2: Getting Started .....	2-1
Chapter 3: Basics of Operation .....	3-1
3.1 Display .....	3-1
3.1.1 Vacuum Fluorescent Display (VFD).....	3-1
3.2 Keyboard .....	3-1
3.2.1 Function Keys .....	3-2
3.2.2 Numeric Keys.....	3-2
3.3 General Scale Operation .....	3-3
3.3.1 Weighing an Item.....	3-3
3.3.2 Taring an Item of Unknown Weight .....	3-3
3.3.3 Taring an Item of Known Weight .....	3-3
3.3.4 Clearing a Tare .....	3-3
3.3.5 Piece Counting.....	3-4
3.3.6 Clearing the Piece Count.....	3-4
Chapter 4: Advanced Features and Operation.....	4-1
4.1 Advanced Piece Counting.....	4-1
4.2 Unit Weight Entry .....	4-1
4.2.1 Unit Weight Entry – First Method.....	4-1
4.2.2 Unit Weight Entry – Second Method.....	4-1
4.3 Memory Accumulator.....	4-2
4.3.1 Displaying the Memory Accumulator .....	4-2
4.3.2 Adding to the Memory Accumulator.....	4-2
4.3.3 Clearing the Memory Accumulator .....	4-2
4.4 Using the Target Value .....	4-2
4.5 Auto Sampling .....	4-3
4.6 Auto Tare.....	4-3

Chapter 5:	Setup.....	5-1
5.1	Setup Overview.....	5-1
5.2	Supervisor Menu.....	5-1
5.2.1	Time Format (TIMFMT).....	5-1
5.2.2	Date Format (DATFMT).....	5-2
5.2.3	Print Format (PRTFMT).....	5-2
5.2.3.1	Margins.....	5-2
5.2.3.2	Header.....	5-3
5.2.3.3	Field Selection.....	5-3
5.2.3.4	Restore Defaults.....	5-4
5.2.3.5	Exiting the Print Format Menu.....	5-4
5.2.4	Setting the Date (SETDATE).....	5-5
5.2.5	Setting the Time (SETTIME).....	5-5
5.2.6	Auto Sample (AUSMPL).....	5-5
5.2.7	Auto Tare (AUTARE).....	5-6
5.2.8	Exiting the Supervisor Menu.....	5-6
5.3	Service Menu.....	5-6
Appendix A:	Specifications.....	A-1
Appendix B:	Serial Port Information.....	B-1
B.1	Default Serial Interface Port Settings.....	B-1
B.2	Suggested Cable Diagram.....	B-1
B.3	Default Print Format.....	B-1
Appendix C:	Error Messages.....	C-1
C.1	Error Messages.....	C-1
C.1.1	Operator Errors.....	C-1

## LIST OF FIGURES

1-1	CSL Series Front Panel.....	1-1
2-1	CSL Back Panel.....	2-1
3-1	CSL Display Detail.....	3-1
3-2	Function Keys Layout.....	3-1
3-3	Numeric Keys Layout.....	3-2
5-1	Supervisor Menu Key Assignments.....	5-1
B-1	Cable Diagram for Scale to Printer.....	B-1
B-2	Default Print Format.....	B-1

## LIST OF TABLES

1-1	CSL Series Product Matrix .....	1-1
3-1	CSL Series Annunciator Definitions.....	3-1
3-2	CSL Sampling Limits.....	3-5
5-1	Entering Alphanumeric Characters .....	5-3
5-2	Field Names and Definitions .....	5-4

## CHAPTER 1: INTRODUCTION TO THE TRANSCCELL CSL SERIES DIGITAL COUNTING SCALE

The Transcell Model CSL Series Digital Counting Scale is an easy to use, high-resolution counting featuring keyboard tare and unit weight entry. It is equipped with many useful features that are normally found on much more expensive scale products, including memory accumulator and target values.

The scale is available in four avoirdupois weight capacities and four metric weight capacities. Table 1-1 shows the CSL series product matrix.

Prior to using the scale, please read this user's guide carefully and completely. Store the manual in a safe and convenient place so it will be available if you have questions concerning the operation of the scale.

MODEL	CAPACITY / GRADUATION	MODEL	CAPACITY / GRADUATION
CSL-12	12 lb x 0.001 lb	CSL-6M	6000 g x 0.5 g
CSL-30	30 lb x 0.002 lb	CSL-15M	15 kg x 1 g
CSL-60	60 lb x 0.005 lb	CSL-30M	30 kg x 2 g
CSL-120	120 lb x 0.01 lb	CSL-60M	60 kg x 5 g

TABLE 1-1: CSL Series Product Matrix

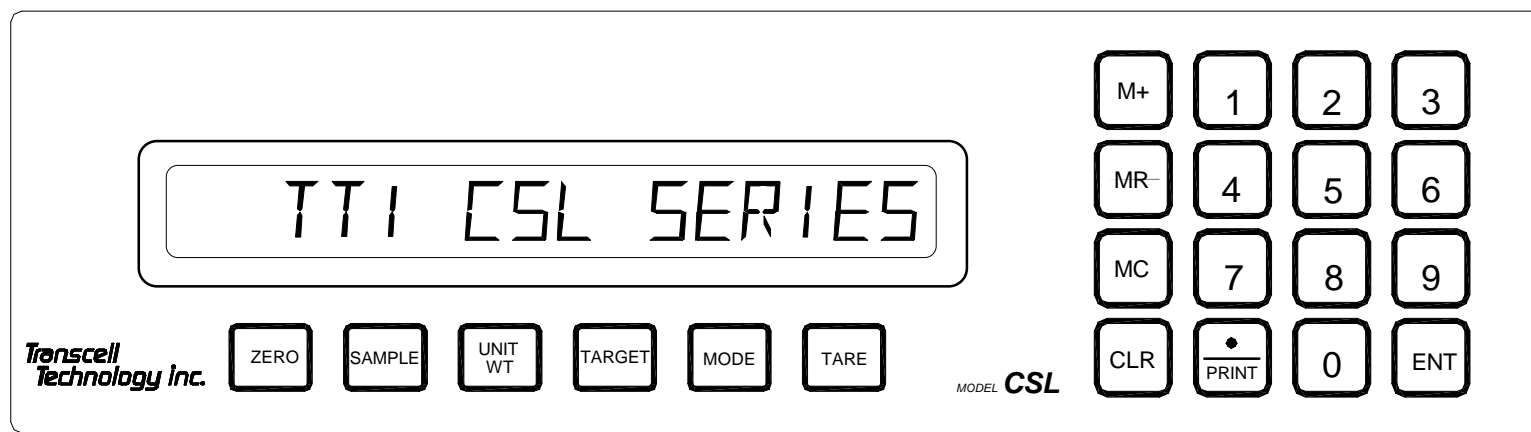
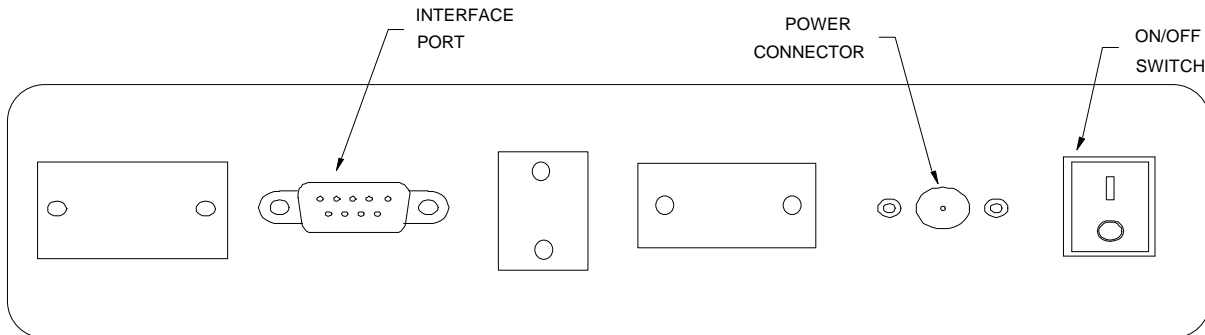

FIGURE 1-1: CSL Series Front Panel



## CHAPTER 2: GETTING STARTED

After unpacking the scale, a small amount of preparation is required before the scale can be used. Please refer to Figure 2-1 below as needed.



**Figure 2-1: CSL Back Panel**

- Step 1.** Position the scale in its area of intended use. Observe the following guidelines for suitable location.
1. Choose a firm, stable floor or table.
  2. Do not share an AC outlet with electrical noise producing equipment, such as refrigeration units. This includes products with electrical motors and/or relays.
  3. Do not place the scale in an area with changing ambient temperature and/or high humidity.
  4. Do not place the scale in an area prone to exposure to direct sunlight, wind, or dust.
  5. Do not place the scale in an area with vibrating equipment.
- Step 2.** Install the AC Adapter.
1. After placing the scale in its area of use, locate the Model A41408 AC Adapter.
  2. Connect the female end of the AC Adapter to the connector on the rear of scale, and then plug the adapter into an AC outlet.
- Step 3.** If applicable, install the serial printer.
1. Connect the printer to the CSL's interface port using the optional serial cable.
  2. Configure the printer's communication parameters as detailed in Appendix B.
  3. Configure the printer's formatting parameters as detailed in Chapter 5.
  4. Set the current Time and Date as detailed in Chapter 5.
- Step 4.** Turn the scale's AC power on to begin use.

## CHAPTER 3: OPERATION

### 3.1 DISPLAY

The Model CSL scale utilizes a 16 character VFD (Vacuum Fluorescent Display) to display the weight and system information.

#### 3.1.1 VACUUM FLUORESCENT DISPLAY (VFD)

Figure 3-1 shows the display detail of the CSL Series. The display consists of 16 alphanumeric characters. The scale uses these characters to display numeric values, units of measure and messages. Table 3-1 lists the various annunciators you may see and their meanings.

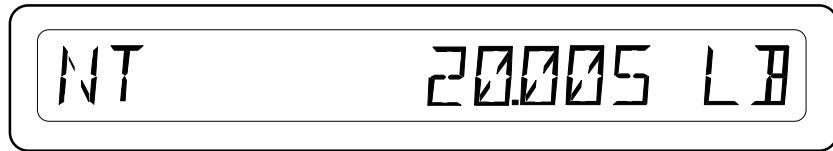

FIGURE 3-1: CSL Display Detail

Annunciator	MEANING
UWT	Indicates that the scale is displaying the unit weight of the items you are counting.
NT	Indicates that the scale is displaying net weight.
LB, KG, PCS	Indicates the unit of the displayed weight.

TABLE 3-1: CSL Series Annunciator Definitions

### 3.2 KEYBOARD

The keyboard is composed of twelve function keys and ten numeric keys. Refer to Figures 3-2 and 3-3 for the overall layout and key locations.

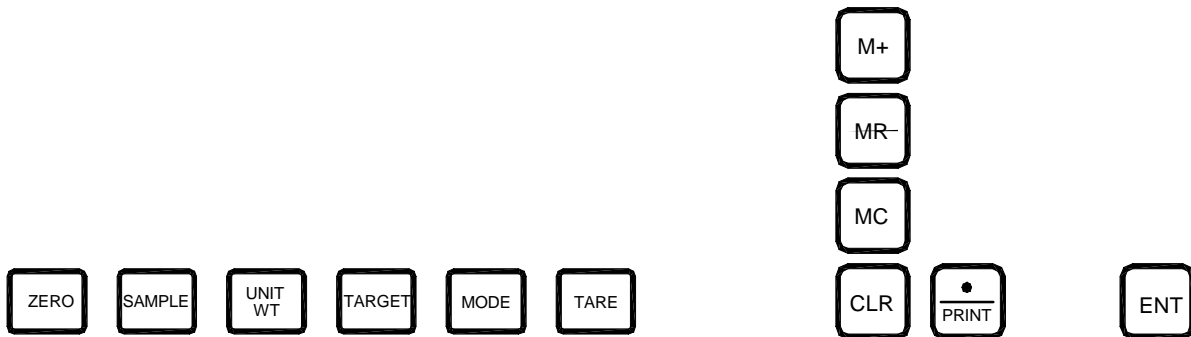

FIGURE 3-2: Function Keys Layout

### 3.2.1 FUNCTION KEYS

**Zero** - This key sets the scale to display zero.

**Sample** – This key puts the scale into sampling mode, which is used for piece counting. See Section 3.3.5 for more information.

**Unit Wt** – This key is used to enter a known unit weight of an item into the scale.

**Target** – This key is used to enter two target values, which are used in conjunction with piece counting. See Section 4.4 for more information.

**Mode** – This key toggles the scale among the available weight units. If a unit weight does not exist in the system, the scale toggles between pound (lb) and kilogram (kg) units. If a unit weight does exist in the system, the scale toggles among pound (lb), kilogram (kg), and pieces (pcs) units. In this situation, one more press of the Mode key displays the unit weight of the items you are counting.

**Tare** - This key is used to establish a Tare provided the scale is not at or below Gross zero.

**CLR** - This key is used to clear the current unit weight and tare from the scale. This key is also used to escape from a prompt or function that you may have entered accidentally.

**Decimal Point / Print** - This key is used to send weight information out to the serial interface port. This key is also used to enter a decimal point when entering numeric values. If no numeric key has been pressed prior to pressing this key, the scale assumes that the PRINT function is desired.

**ENT** - This key is used to enter a numeric entry and to answer “YES” to a Yes/No question.

**M+** - This key is used to add the current number of pieces displayed to the memory accumulator. See Section 4.3 for more information.

**MR** - This key is used to temporarily display the contents of the memory accumulator. See Section 4.3 for more information.

**MC** - This key is used to clear the memory accumulator. See Section 4.3 for more information.

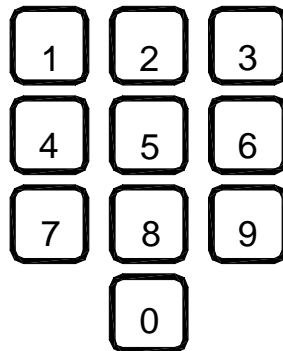

**FIGURE 3-3: Numeric Keys Layout**

### 3.2.2 NUMERIC KEYS

**0-9** – These keys are used to enter numeric and alphanumeric data into the scale.

### **3.3 GENERAL SCALE OPERATION**

#### **3.3.1 WEIGHING AN ITEM**

1. Select the desired weighing unit by pressing the MODE key until that unit is indicated on the display.
2. If necessary, press the ZERO key to obtain a weight reading of zero.
3. Place the object to be weighed on the scale's platter and allow the weight indication to stabilize. If the item weight exceeds the scale's weight capacity, it displays "OVER WEIGHT".
4. Read the weight shown on the display.

#### **3.3.2 TARING AN ITEM OF UNKNOWN WEIGHT**

To weigh an item in a container, the weight of that container must first be subtracted from the overall weight to obtain an accurate weight reading. This is known as taring.

1. Select the desired weighing unit by pressing the MODE key until that unit is indicated on the display.
2. If necessary, press the ZERO key to obtain a weight reading of zero.
3. Place the empty container on the scale's platter and allow the weight indication to stabilize.
4. Press the TARE key. The display shows zero weight and turns the NT annunciator on.
5. Place the material to be weighed in the container and allow the weight indication to stabilize.
6. Read the weight shown on the display.

#### **3.3.3 TARING AN ITEM OF KNOWN WEIGHT**

If the weight of the container or object is known, you may enter this weight via the keyboard. This value must be rounded to the nearest scale division. For example, on a 60 x 0.005 lb scale, you must enter the tare weight value to the nearest 0.005 lb.

1. Select the desired weighing unit by pressing the MODE key until that unit is indicated on the display.
2. Using the numeric keys, key-in the known tare weight.
3. Press the TARE key. The display shows zero weight and turns the NT annunciator on.
4. Place the material to be weighed in the container and allow the weight indication to stabilize.
5. Read the weight shown on the display.

#### **3.3.4 CLEARING A TARE**

1. To clear a tare, press the CLR key at any time. The NT annunciator disappears and the gross weight is displayed.

### 3.3.5 PIECE COUNTING

This mode is used to indicate the number of pieces of an item you have placed on the scale's platform and is accessed by pressing the SAMPLE key. To ensure accuracy, the parts you are counting must be consistent in weight.

The scale uses the sampling method to determine the average piece weight (APW) of the items you wish to count. When sampling items, always count the parts in your hand and place them on the platform all at once. If the APW of the items is too light or the total weight of the sample is too light, accuracy cannot be guaranteed. You will get an error message, but piece counting will still be allowed. Consult Table 3-2 for minimum piece weights and sample weights.

1. If the items you will be counting require a container, you must first tare the container off by pressing the TARE key.
2. Press the SAMPLE key. The scale will display "Add 10 PCS". The scale is prompting you to place ten identical items on the platform.

**NOTE:** If you wish to change the sample number, simply press the SAMPLE key repeatedly until the desired sample number appears. Available choices are 5, 10, 25, 50, 100, 200, 500 and 1000. If you have a non-standard sample amount, refer to Section 4.1 for an alternative sampling procedure.

3. Place the sample items on the platform all at once. Once the scale stabilizes, the scale will prompt you to press the ENT key.
4. Press the ENT key to take the sample. If the sample meets the limits shown in Table 3-2, the scale will now display the number of pieces on the scale. If it does not, the scale briefly displays an error message, but still allows piece counting. If this occurs, you should use a higher sample amount to achieve better piece count accuracy. Please see Appendix C for an explanation of the error messages.

**NOTE:** If the scale displays a "Low Resolution" message, the unit weight of the items you wish to count is too light for your scale to process at all.

### 3.3.6 CLEARING THE PIECE COUNT

1. To clear the piece count, either press the CLR key to erase the sample or press the SAMPLE key to take a new sample.

<b>MODEL</b>	<b>Capacity / Graduation</b>	<b>Minimum Piece Weight</b>	<b>Minimum Sample Weight</b>
CSL-12	12 lb x 0.001 lb	0.0008 lb	0.025 lb
CSL-30	30 lb x 0.002 lb	0.0016 lb	0.050 lb
CSL-60	60 lb x 0.005 lb	0.0040 lb	0.125 lb
CSL-120	120 lb x 0.01 lb	0.0080 lb	0.250 lb
CSL-6M	6000 g x 0.5 g	0.4 g	12.5 g
CSL-15M	15 kg x 1 g	0.8 g	25.0 g
CSL-30M	30 kg x 2 g	1.6 g	50.0 g
CSL-60M	60 kg x 5 g	4.0 g	125.0 g

**TABLE 3-2: CSL Sampling Limits**

## CHAPTER 4: ADVANCED FEATURES AND OPERATION

### 4.1 ADVANCED PIECE COUNTING

If your sample amount is different from those available in Section 3.3.5, then use this procedure.

1. If the items you will be counting require a container, you must first tare the container off by pressing the TARE key.
2. Place the sample items on the platform all at once.
3. Using the numeric keys, key-in the actual number of items in your sample.
4. Press the SAMPLE key to take the sample. If the sample meets the limits shown in Table 3-2, the scale will now display the number of pieces on the scale. If it does not, the scale briefly displays an error message, but still allows piece counting. If this occurs, you should use a higher sample amount to achieve better piece count accuracy. Please see Appendix C for an explanation of the error messages.

**NOTE:** If the scale displays a “Low Resolution” message, the unit weight of the items you wish to count is too light for your scale to process at all.

### 4.2 UNIT WEIGHT ENTRY

If you already know the unit weight of the items you wish to count, then use one of the following procedures.

#### 4.2.1 UNIT WEIGHT ENTRY – FIRST METHOD

1. Press the MODE key until the proper unit (LB or KG) of the known unit weight is displayed.
2. Press the UNIT WT key. The scale prompts you to enter the unit weight.
3. Using the numeric keys, key-in the actual unit weight value.
4. Press the ENT key. If the unit weight is large enough, the scale will now display the number of pieces on the scale. If it does not, the scale briefly displays an error message, but still allows piece counting. Please see Appendix C for an explanation of the error messages.

**NOTE:** If the scale displays a “Low Resolution” message, the unit weight of the items you wish to count is too light for your scale to process at all.

#### 4.2.2 UNIT WEIGHT ENTRY – SECOND METHOD

1. Press the MODE key until the proper unit (LB or KG) of the known unit weight is displayed.
2. Using the numeric keys, key-in the actual unit weight value.
3. Press the UNIT WT key. If the unit weight is large enough, the scale will now display the number of pieces on the scale. If it does not, the scale briefly displays an error message, but still allows piece counting. Please see Appendix C for an explanation of the error messages.

**NOTE:** If the scale displays a “Low Resolution” message, the unit weight of the items you wish to count is too light for your scale to process at all.

## 4.3 MEMORY ACCUMULATOR

Your scale comes equipped with a handy memory accumulator, which can be used in conjunction with the piece counting feature. As with a hand-held calculator, the memory accumulator can be added to, displayed and cleared at anytime.

**NOTE:** This feature can be used when in PCS mode only.

### 4.3.1 DISPLAYING THE MEMORY ACCUMULATOR

1. Press the MR key. The scale briefly displays the total number of pieces, followed by the total number of entries.

### 4.3.2 ADDING TO THE MEMORY ACCUMULATOR

1. Press the M+ key. The scale adds the current number of pieces to the memory accumulator, then briefly displays the total number of pieces, followed by the total number of entries.

### 4.3.3 CLEARING THE MEMORY ACCUMULATOR

1. Press the MC key. The scale asks if you wish to clear the memory accumulator.
2. Press the ENT key to clear the accumulator memory or press the CLR if you do not wish to clear the accumulator memory.

## 4.4 USING THE TARGET VALUE

This function works in conjunction with the piece counting feature and allows your scale to act as a checkweigher. This is useful if you are filling a container with a pre-determined amount of items.

To use, you must enter two values – a lower limit value and an upper limit value. These are chosen based on the tolerance of your target value. For example, if you wish to fill a bottle with 100 items and you have a tolerance of  $\pm 2$  pieces, you would set your lower limit value to 98 and your upper limit value to 102. The lower and upper limit values may be the same if you have no tolerance allowance.

If the number of items on the platform is within the two limits, the scale flashes “TGT” and beeps.

**NOTE:** This feature can be used when in PCS mode only.

1. Press the TARGET key. The scale prompts for the lower limit value.
2. Use the numeric keys to key-in the lower limit value then press the ENT key. The scale prompts for the upper limit value.
3. Use the numeric keys to key-in the upper limit value then press the ENT key.
4. Place items on scale until the scale signals that the items are within the entered limits.

**NOTE:** To exit the target function, enter a value of zero for the lower limit value.



## 4.5 AUTO SAMPLING

Auto Sampling is a feature that allows you to sample items without pressing the ENT key. This feature must be first be enabled in the Supervisor Menu before it can be used. Refer to Section 5.2.6 on how to do this.

Auto Sampling may be used in conjunction with Auto Tare described in the following section. Refer to Section 3.3.5 for sampling limits.

1. If the items you will be counting require a container, you must first tare the container off by pressing the TARE key.
2. Press the SAMPLE key. The scale will display “Add 10 PCS”. The scale is prompting you to place ten identical items on the platform.

**NOTE:** If you wish to change the sample number, simply press the SAMPLE key repeatedly until the desired sample number appears. Available choices are 5, 10, 25, 50, 100, 200, 500 and 1000. If you have a non-standard sample amount, refer to Section 4.1 for an alternative sampling procedure.

3. Place the sample items on the platform all at once. Once the scale stabilizes, the scale will automatically take the sample. If the sample meets the limits shown in Table 3-2, the scale will now display the number of pieces on the scale. If it does not, the scale briefly displays an error message, but still allows piece counting. If this occurs, you should use a higher sample amount to achieve better piece count accuracy. Please see Appendix C for an explanation of the error messages.

**NOTE:** If the scale displays a “Low Resolution” message, the unit weight of the items you wish to count is too light for your scale to process at all.

## 4.6 AUTO TARE

Auto Tare is a feature that allows you to sample items without pressing the TARE key. This feature must be first be enabled in the Supervisor Menu before it can be used. Refer to Section 5.2.7 on how to do this.

Auto Tare may be used in conjunction with Auto Sampling described in the previous section. Refer to Section 3.3.5 for sampling limits.

1. If the items you will be counting require a container, place the container on the platform.
2. Press the SAMPLE key. The scale automatically tares the weight of the container and displays “Add 10 PCS”. The scale is prompting you to place ten identical items on the platform.

**NOTE:** If you wish to change the sample number, simply press the SAMPLE key repeatedly until the desired sample number appears. Available choices are 5, 10, 25, 50, 100, 200, 500 and 1000. If you have a non-standard sample amount, refer to Section 4.1 for an alternative sampling procedure.

3. Place the sample items on the platform all at once. Once the scale stabilizes, the scale will prompt you to press the ENT key.
4. Press the ENT key to take the sample. If the sample meets the limits shown in Table 3-2, the scale will now display the number of pieces on the scale. If it does not, the scale briefly displays an error message, but still allows piece counting. If this occurs, you should use a higher sample amount to achieve better piece count accuracy. Please see Appendix C for an explanation of the error messages.

**NOTE:** If the scale displays a “Low Resolution” message, the unit weight of the items you wish to count is too light for your scale to process at all.

## CHAPTER 5: SETUP

### 5.1 SETUP OVERVIEW

The system setup consists of two setup areas: Supervisor Menu and Setup Menu. The Supervisor Menu allows configuration of items that customize operation of your scale. The Service Menu allows configuration of items that are more technical in nature. The Service Menu contains information on how to re-calibrate your scale.

### 5.2 SUPERVISOR MENU

The Supervisor Menu is used to configure the formatting of the information sent to your printer, set the time & date and enable some of the advanced features.

To maneuver through the Supervisor Menu, use the key assignments shown in Figure 5-1.

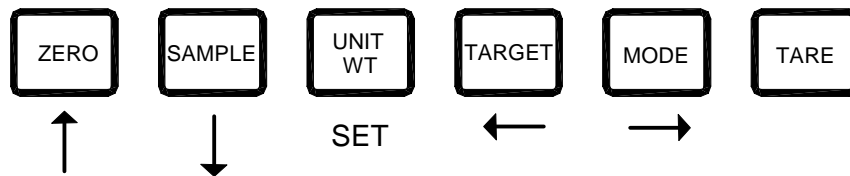

**FIGURE 5-1: Supervisor Menu Key Assignments**

1. Press and hold the 8 key at any time.
2. When the scale beeps twice, release the 8 key. The scale displays "MENU SUPER".
3. Press the SAMPLE (Down) key. The scale prompts for a password.
4. Key-in the Supervisor Menu password (1234). There is no need to press the ENT key. You are now in the Supervisor Menu.

#### 5.2.1 TIME FORMAT (TIMFMT)

This function is used to select how the current time is printed on your printer. You may choose between 12 Hour (AM/PM) and 24 Hour (Military). The default setting is 12 Hour.

1. Enter the Supervisor Menu as described above. The scale displays "SUPER TIMFMT".
2. Press the SAMPLE (Down) key. The scale displays the current setting in the format "TIMFMT XX HR".
3. Using the MODE (Right) or TARGET (Left) keys to toggle between 12 Hour and 24 Hour.
4. Once the desired format appears, press the UNIT WT (Set) key to save the changes.
5. Press the ZERO (Up) key to return to the "SUPER TIMFMT" message.

## 5.2.2 DATE FORMAT (DATFMT)

This function is used to select how the current date is printed on your printer. You may choose between Standard (mm/dd/yy) and International (dd/mm/yy). The default setting is Standard.

1. Enter the Supervisor Menu as described above. The scale displays "SUPER TIMFMT".
2. Press the MODE (Right) key until the scale displays "SUPER DATFMT".
3. Press the SAMPLE (Down) key. The scale displays the current setting in the format "DATFMT XXXX".
4. Using the MODE (Right) or TARGET (Left) keys to toggle between Standard (Std) and International (Intl).
5. Once the desired format appears, press the UNIT WT (Set) key to save the changes.
6. Press the ZERO (Up) key to return to the "SUPER DATFMT" message.

## 5.2.3 PRINT FORMAT (PRTFMT)

This function is used to configure how the information appears on your printer. This sub-menu consists of Margin, Header, and Field Selection.

1. Enter the Supervisor Menu as described above. The scale displays "SUPER TIMFMT".
2. Press the MODE (Right) key until the scale displays "SUPER PRTFMT".
3. Press the SAMPLE (Down) key. The scale displays "PRTFMT MARGIN".

### 5.2.3.1 MARGINS

This function is used to configure left margin on your printer. To use, enter the number of spaces to be printed prior to a line of information. The default setting is zero.

1. Enter the Print Format sub-menu as described above. The scale displays "PRTFMT MARGIN".
2. Press the SAMPLE (Down) key. The scale displays "MARGIN" followed by the current setting.
3. Use the numeric keys to enter in the new value and press the ENT key or just press the UNIT WT key to keep the current value.

### 5.2.3.2 HEADER

This function allows three alphanumeric messages to be printed at the top of each printout. For example, your company name and address can be entered and printed. The default header messages can be found in Appendix B.

**NOTE:** You cannot view the current message in this function. You must press the CLR key if you wish to exit without overwriting the current message.

1. Enter the Print Format sub-menu as described above. The scale displays "PRTFMT MARGIN".
2. Press the MODE (Right) key until the scale displays "PRTFMT MESSAGE".
3. Press the SAMPLE (Down) key. The scale displays "MSG1" followed a flashing underscore.
4. Use the numeric keys to enter your new message. Use Table 5-1 as a guide to entering alphanumeric characters.
5. When finished with your message, press the ENT key.
6. Repeat Step #4 for Message 2 (MSG2) and Message 3 (MSG3).

"0" = 0 + 0	"1" = 0 + 1	"2" = 0 + 2	"3" = 0 + 3	"4" = 0 + 4	"5" = 0 + 5	"6" = 0 + 6
"7" = 0 + 7	"8" = 0 + 8	"9" = 0 + 9	"A" = 2 + 1	"B" = 2 + 2	"C" = 2 + 3	"D" = 3 + 1
"E" = 3 + 2	"F" = 3 + 3	"G" = 4 + 1	"H" = 4 + 2	"I" = 4 + 3	"J" = 5 + 1	"K" = 5 + 2
"L" = 5 + 3	"M" = 6 + 1	"N" = 6 + 2	"O" = 6 + 3	"P" = 7 + 1	"Q" = 7 + 2	"R" = 7 + 3
"S" = 7 + 4	"T" = 8 + 1	"U" = 8 + 2	"V" = 8 + 3	"W" = 9 + 1	"X" = 9 + 2	"Y" = 9 + 3
"Z" = 9 + 4	"_" = 1 + 1					

**TABLE 5-1: Entering Alphanumeric Characters**

### 5.2.3.3 FIELD SELECTION

This function allows you to specify which fields to print. The order in which the fields appear are fixed and appear in Table 5-2.

1. Enter the Print Format sub-menu as described above. The scale displays "PRTFMT MARGIN".
2. Press the MODE (Right) key until the scale displays "PRTFMT FIELDS".
3. Press the SAMPLE (Down) key. The scale displays "MESSAGE 1" followed by its status – No or Yes. "No" indicates that it is not printed.
4. Use the MODE (Right) or TARGET (Left) keys to toggle the status ON or OFF.
5. Press the ENT key to save the field status.
6. Repeat Steps #3 through #5 for the remainder of the fields listed in Table 5-2.
7. When finished, press the CLR key to exit back to the "PRTFMT FIELDS" screen.

<b>FIELD NAME</b>	<b>DEFINITION</b>
MESSAGE 1	The first alphanumeric message printed in the header.
MESSAGE 2	The second alphanumeric message printed in the header.
MESSAGE 3	The third alphanumeric message printed in the header.
GROSS WT	The gross weight.
TARE WT	The container weight tared from the scale.
NET WT	The net weight which is gross weight minus tare weight.
UNIT WT	The unit weight of the items you are counting.
PIECES	The number of pieces currently on the platform.
TOTAL PCS	The total number of pieces stored in the memory accumulator.
TOTAL ENT	The total number of entries you have stored in the memory accumulator.
DATE	The current date.
TIME	The current time.

**TABLE 5-2: Field Names and Definitions**

#### **5.2.3.4 RESTORE DEFAULTS**

This function allows you reset all print format parameters back to the factory default.

1. Enter the Print Format sub-menu as described above. The scale displays "PRTFMT MARGIN".
2. Press the MODE (Right) key until the scale displays "PRTFMT DEFAULT".
3. Press the SAMPLE (Down) key. The scale automatically restores the default settings and returns to the "PRTFMT DEFAULT" screen.

#### **5.2.3.5 EXITING THE PRINT FORMAT MENU**

1. Press the ZERO (Up) key to return to the "SUPER PRTFMT" screen.

#### **5.2.4 SETTING THE DATE (SETDATE)**

This function is used to set the current date into the scale.

1. Enter the Supervisor Menu as described above. The scale displays "SUPER TIMFMT".
2. Press the MODE (Right) key until the scale displays "SUPER SETDATE".
3. Press the SAMPLE (Down) key. The scale displays the current date setting in Standard (mm/dd/yy) format.
4. Use the numeric keys to key-in the current date in Standard (mm/dd/yy) format. For example, for January 7, 1998 you would enter 010798. For November 30, 1998 you would enter 113098. There is no need to press the ENT key.

#### **5.2.5 SETTING THE TIME (SETTIME)**

This function is used to set the current time into the scale.

1. Enter the Supervisor Menu as described above. The scale displays "SUPER TIMFMT".
2. Press the MODE (Right) key until the scale displays "SUPER SETTIME".
3. Press the SAMPLE (Down) key. The scale displays the current time setting in 24-Hour (Military) format.
4. Use the numeric keys to key-in the current time in 24-Hour (Military) format. For example, for 9:00 AM you would enter 090900. For 5:00 PM you would enter 170000. (The last two digits are the seconds). There is no need to press the ENT key.

#### **5.2.6 AUTO SAMPLE (AUSMPL)**

This function is used to enable or disable the auto-sampling feature described in Section 4.5. The default setting is disabled.

1. Enter the Supervisor Menu as described above. The scale displays "SUPER TIMFMT".
2. Press the MODE (Right) key until the scale displays "SUPER AUSMPL".
3. Press the SAMPLE (Down) key. The scale displays the current state of auto sampling – ENABLE or DISABLE.
4. Use the MODE (Right) or TARGET (Left) keys to toggle the status between ENABLE and DISABLE.
5. Press the UNIT WT (Set) key to save your selection.
6. Press the ZERO (Up) key to return to the "SUPER AUSMPL" screen.

### **5.2.7 AUTO TARE (AUTARE)**

This function is used to enable or disable the auto tare feature described in Section 4.6. The default setting is disabled.

1. Enter the Supervisor Menu as described above. The scale displays "SUPER TIMFMT".
2. Press the MODE (Right) key until the scale displays "SUPER AUTARE".
3. Press the SAMPLE (Down) key. The scale displays the current state of the auto tare – ENABLE or DISABLE.
4. Use the MODE (Right) or TARGET (Left) keys to toggle the status between ENABLE and DISABLE.
5. Press the UNIT WT (Set) key to save your selection.
6. Press the ZERO (Up) key to return to the "SUPER AUTARE" screen.

### **5.2.8 EXITING THE SUPERVISOR MENU**

1. Press the CLR key twice to return to Normal Operating Mode.

## **5.3 SERVICE MENU**

This menu is covered in a separate service document.

## APPENDIX A: SPECIFICATIONS

### CONSTRUCTION:

**Housings:** Gray ABS  
**Sub-Platform:** Metal  
**Platter:** Stainless Steel  
**Feet:** Non-skid Hard Rubber

### DISPLAY:

16 x 1 Alpha, Vacuum Fluorescent

### KEYPAD:

22-key Tactile Keypad

### OVER CAPACITY ANNUNCIATION:

103% of Full Scale Capacity

### OPERATING TEMPERATURE RANGE:

32°F to 104°F  
(0°C to 40°C)

### POWER SOURCE:

AC Adapter, 12VDC, 800 mA,  
included

### SERIAL PORT:

Full Duplex RS-232,  
Male DSUB9

### WEIGHT:

Net Weight: 23.0 lb (10.4 kg)  
Shipping Weight: 24.0 lb (10.8 kg)

---

### PHYSICAL DIMENSIONS:

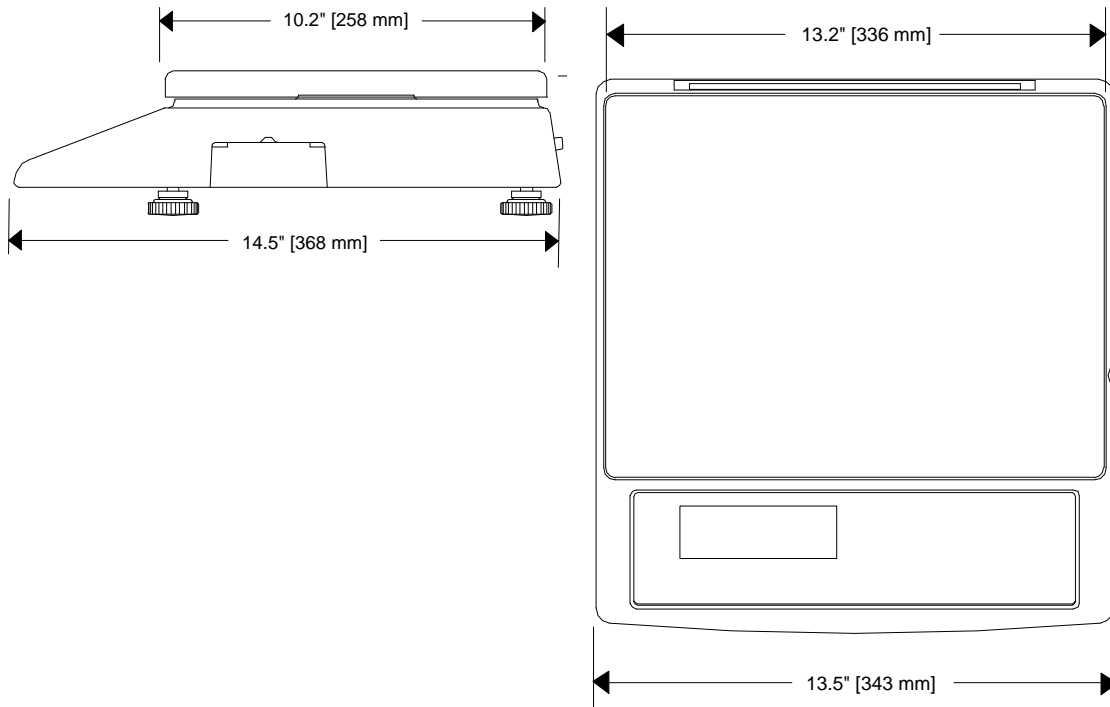



## APPENDIX B: SERIAL PORT INFORMATION

### B.1 DEFAULT SERIAL INTERFACE PORT SETTINGS

Baud Rate: 2400  
Data Bits: 8  
Parity: None  
Stop Bits: 1

### B.2 SUGGESTED CABLE DIAGRAM

Figure B-1 shows a suggested cable diagram for interfacing to a serial printer.

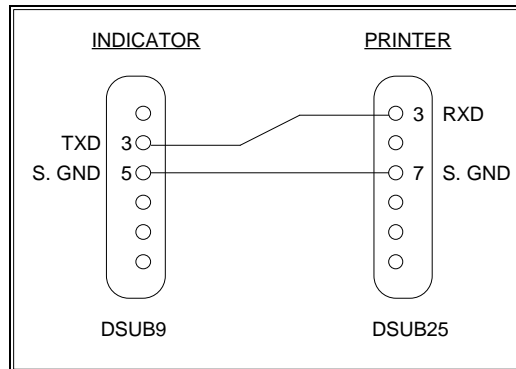

FIGURE B-1. Cable Diagram for Scale to Printer

### B.3 DEFAULT PRINT FORMAT

Figure B-2 shows the fixed format of the print format. The fields can be enabled or disabled as described in Section 5.2.3.

```
YOUR COMPANY HERE
123 MAIN ST
ANYWHERE, US 12345

GROSS WT : 25.000 lb
NET WT   : 23.520 lb
UNIT WT  : 0.0190 lb
TARE WT  : 1.480 lb
PIECES   : 1238
TOTAL PCS : 1238
TOTAL ENT : 1
DATE     : 07/17/98
TIME     : 12:34 PM
```

FIGURE B-2: Default Print Format

## APPENDIX C: ERROR MESSAGES

### C.1 ERROR MESSAGES

If the scale encounters an error condition, it will display a message alerting the operator. A description of each display follows:

#### C.1.1 OPERATOR ERRORS

<b>Message</b>	<b>Explanation</b>
<i>OVER WEIGHT</i>	Indicates that the weighing capacity of the scale has been exceeded.
<i>Low Resolution</i>	Indicates that there is not enough internal resolution to calculate the unit weight of an item. This means that the items you are counting are too light for the scale to process at all.
<i>Unit Wt too Light</i>	Indicates that unit weight of the items you are sampling is too light for the scale to process accurately.
<i>Smp Wt too Light</i>	Indicates that total weight of the items you are sampling is too light for the scale to process accurately.
<i>Invalid Data</i>	Indicates that the tare weight value you are entering is not rounded to the nearest scale division. For example, you cannot enter 0.01 lb for a 0.05 lb increment scale.
<i>Over Capacity</i>	Indicates that the tare weight value or unit weight value you are entering exceeds the capacity of the scale.