



TRANSCCELL TECHNOLOGY, INC.

EL 3000

Digital Scale

Operation Manual

Revision 1.1
April 16, 2002

© 1995-2002 Transcell Technology, Inc.

Contents subject to change without notice.

Transcell Technology, Inc.
975 Deerfield Parkway
Buffalo Grove, IL 60089
Tel (847) 419-9180
Fax (847) 419-1515
E-mail: transcell@transcell.net
Web: www.transcell.net

ATTENTION:

To extend the life of your electronic scale, do not drop items to be weighed onto the platform or overload the scale beyond its rated capacity. Shock-loading and overloading may damage the electronic components and void the warranty.

Table of Contents

Introduction	1
Getting Started.....	1
Basics of Operation	2
Percentage Operation	3
Piece Counting Operation	4
Accumulator Function Operation.....	5
Disabling or Enabling Units	6
User Configuration.....	7
User Menu Descriptions	8
Multi-Item Print.....	8
Optional Battery Operation	9
Calibration.....	10
Serial Data Formats.....	11
Specifications	13
Displayed Error Messages	13
In Case of Trouble.....	14
Warranty and Service Information.....	15

Introduction

The EL-3000 Counting Scale, available in several capacities, is an easy to use, high resolution counting scale featuring several programmable weigh modes, multi-item print function, and a weight accumulator.

Housed in a durable ivory-colored plastic enclosure, the unit displays its numerals on a 5½-digit LCD type display. A removable 8"x 9" stainless steel platform allows for easy cleaning when used to count greasy or dusty items. A plastic skirt is also included to protect the scale's outer enclosure.

The unit can transmit on demand or continuously in a popular data protocol. A multi-item print mode is also included for use with a printer.

A 5-key membrane panel contains all of the scale's functions. A durable 8" x 9" stainless steel platform allows for accurate piece counting.

A battery power option is available which allows the unit to operate for approximately 10 hours on a charge. The scale can then be charged overnight in a period of 8 to 10 hours.

Getting Started

After unpacking the scale, a small amount of assembly is required:

- Locate the sub-platform, four (4) Hex screws, and enclosed Allen wrench. Place sub-platform onto scale's load point with all rubber parts facing up. Install and tighten the four Hex screws.
- Plug the enclosed adapter into the scale first, then an AC outlet.
- If using the scale with a printer or remote device, plug the connecting serial cable into the DB-9 connector on the back of the scale.
- If the optional battery operation was ordered, please charge the battery overnight before using. See Optional Battery Operation on Page 9 for more information.

Please Do...

- Place the scale on a firm and stable floor or table.
- If possible, leave the scale on for at least 20 minutes before using. You will find the ON/OFF switch at the bottom of the scale on the right, towards the back.
- Press the **ZERO** key before operating the scale.

Please Do Not...

- Share an AC outlet with other noise producing products; i.e. anything with an electrical motor or relay.
- Operate the scale...
 - ...in an area with changing ambient temperature.
 - ...in direct sunlight.
 - ...in an area with high humidity.
 - ...in a dusty environment.
 - ...in a windy area.
 - ...in an area with vibration.

Basics of Operation

DISPLAY & KEYPAD OVERVIEW

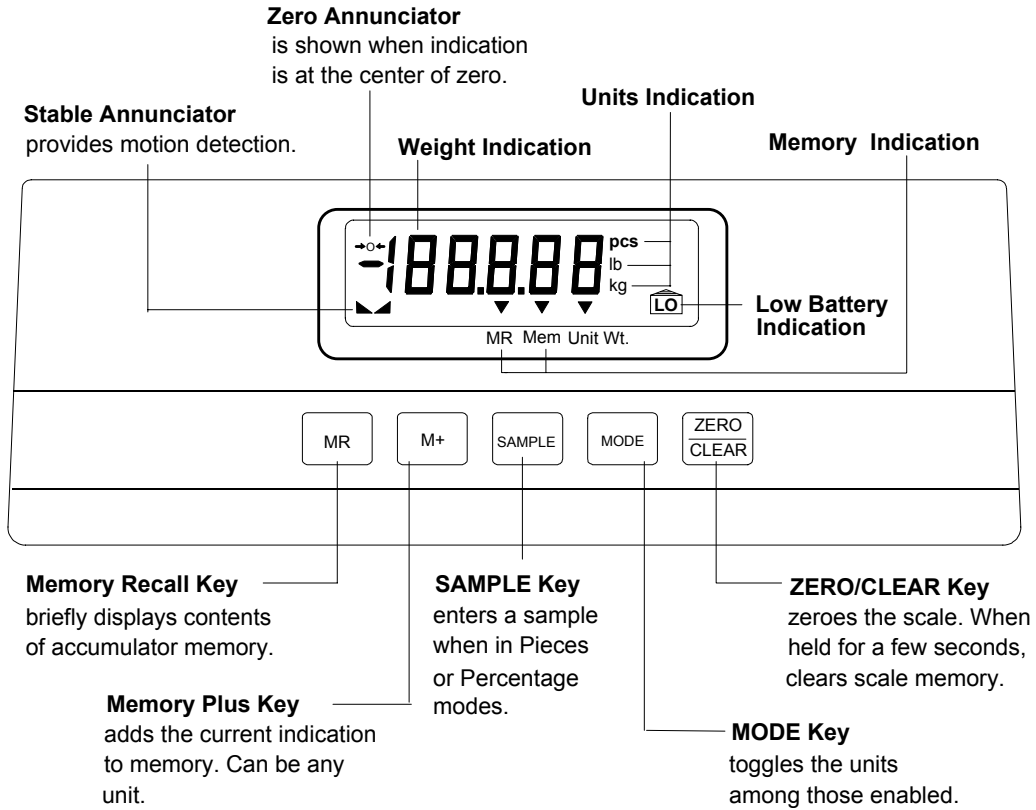

INDICATION	MEANING
Weight	Indicates the weight currently on the platform. When the full scale capacity has been exceeded, the scale shows "□□□□□."
Units	Indicates the unit of the weight currently on the platform. The Unit Wt. indicator shows the unit weight of a piece sampled while in the pieces mode.
Memory	"MEM" indicates that there is a reading in memory. "MR" indicates that the reading on the display is from the memory accumulator.
Zero	Indicates that the weight reading is at the scale's zero position.
Stable	Indicates that the scale is stable and that the reading on the scale is valid.
Low Battery	If the optional battery operation was ordered, indicates that the internal battery needs charging. See Optional Battery Operation on Page 9 For more information.

Percentage Operation

The EL 3000 Digital Scale contains a percentage operation which is useful for such applications as filling, check weighing and moisture determination.

The total weight of the item being sampled determines the resolution of the percentage readout. For example, if the sample weight is greater than or equal to 10,000 external scale divisions, the scale will discern 0.01% increments. See table below more information.

To use the percentage operation:

1. Toggle the **MODE** key until the scale is in “%” mode. If there is no previous sample entered, the scale will respond with the following display indication. If the following message does not appear, press the **SAMPLE** key once.

This display indication is prompting you to place 100% of the sample on the platform all at once. **NOTE:** If you entered this screen by accident, you can press the **MODE** key to escape.

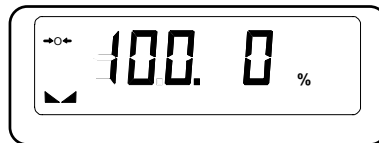

2. Press the **ZERO** key to zero the scale.
3. Place the sample on the platform all at once. When the "Stable" flag becomes lit, the display should look like this:

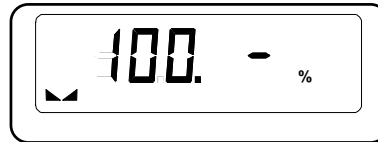

4. Press the **SAMPLE** key. If the sample weight is over the required sample weight, the scale will now show the sample as being 100%. If not, a “Lo” message will flash briefly, prompting you for a heavier sample. See table below for more information.

Percentage Operation Sample Weight Guide:

The minimum sample weight is 100 scale graduations. This will allow the scale to discern 1 part in 100. To get a higher resolution, use 1,000 or even 10,000 times the scale’s graduations as your sample weight. Below are three examples to help determine the best sample weight for your application.

Capacity / Graduation	Minimum Sample Weight (100 Graduations)	Best Sample Weight (10,000 Graduations)
30 lbs x 0.002-lbs	0.200-lbs	20-lbs
1200 g x 0.1 g	10 g	1000 g
6 lbs x 0.0005-lbs	0.05-lbs	5-lbs

Piece Counting Operation

The EL 3000 Digital Scale uses the **sampling** method to determine the number of pieces on the platform. The accuracy of this operation depends upon part consistency and sample weight. When sampling pieces, always count the parts in your hand and place them on the platform all at once.

To further increase the accuracy of this operation, the EL 3000 contains an algorithm called "Automatic Average Weight Improvement" (AAWI) which allows updating of the piece count

by applying small quantities of pieces – two to current piece count – to the platform. For example, if the current piece count shown on the display is 10, then adding 2 to 10 more pieces to the platform at the same time will trigger AAWI. When this occurs, the "Unit Wt." indication will flash briefly.

The total sample weight and the unit piece weight both have limits to assure accuracy. These limits can be found in the table at the bottom of the page.

To use the piece counting operation:

1. Toggle the **MODE** key until the scale is in "pcs" mode. If there is no previous sample entered, the scale will respond with the following display indication. If the following message does not appear, press the **SAMPLE** key once.

This display indication is prompting you to place 10 identical samples on the platform all at once. **NOTE:** If you entered this screen by accident, you can press the **MODE** key to escape.

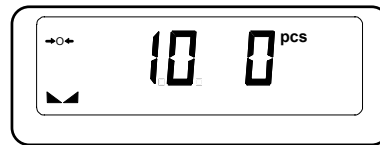

2. Press the **ZERO** key to zero the scale.
3. Place 10 identical samples on the platform all at once. When the "Stable" flag becomes lit, the display should look like this:

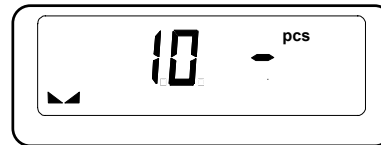

4. Press the **SAMPLE** key. If the sample weight and/or unit weight is within the proper limits, the scale will now show the number of pieces. If not, you will be prompted to place **20, 50, 100, 200 and 500** pieces on the platform in succession. If this operation fails even with 500 pieces, the unit weight of the objects you wish to count is not heavy enough for the scale to process accurately. See table below for more information.

Piece Count Sample Weight Guide:

The scale has both a minimum piece weight and a minimum sample weight to ensure accuracy. To obtain the minimum piece weight, multiply the scale's graduation by 0.8. To obtain the minimum sample weight, multiply the scale's graduation by 25. Shown below is an example for a 12 lb scale:

Capacity / Graduation	Minimum Piece Weight	Minimum Sample Weight
12 lbs x 0.001-lbs	0.0008-lbs	0.025-lbs

Accumulator Function Operation

The EL-3000 comes equipped with a handy accumulator function which works in conjunction with all of the scale's displayable units except Unit Weight. The accumulator uses a memory to store the weight readings and piece counts. Much like a pocket calculator, this memory can be added to, displayed, and cleared at any time.

When used with a printer, the EL-3000 prints the weight each time the **M+** key is pressed and prints the accumulated total when the **MR** key is pressed. See Multi-Item Print on Page 8 for more information.

To use the accumulator function:

1. Use the **MODE** key to toggle to the desired unit you wish to count.
2. If the "MEM" indication is lit, press and hold the **ZERO/CLEAR** key to clear the accumulator memory. The scale briefly displays "CL" to indicate that memory has been cleared.
3. Place the objects to count on the platform.
4. After the "STABLE" indication becomes lit, press the **M+** key to add this value to the accumulator's memory. The scale reading flashes once and the "MEM" indication becomes lit to show that there is a value in memory.
5. Repeat steps 3 & 4 until all pieces are counted.
6. Press the **MR** key to briefly view the contents of the accumulator. The "MR" indication turns on to indicate that the reading is from memory.

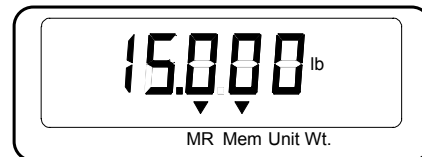
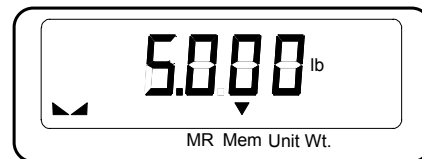

Disabling or Enabling Units

This section is for users who wish to disable some of the available weight units displayable on the EL-3000.

When first purchased, the EL-3000 comes with all available displayable units enabled. The units appear in the following sequence with each press of the **MODE** key:

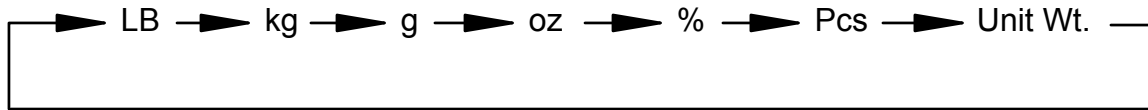

NOTE: If the Pieces mode is disabled, the Unit Wt. Mode will automatically be disabled.

To enable or disable displayable units:

1. Turn the scale off. You will find the ON/OFF switch on the bottom of the scale, near the back.
2. While holding down the **MODE** key, turn the scale back on. Continue holding down the **MODE** key until the scale shows the “LB” unit with either the “ON” message or the “OFF” message.

The “ON” and “OFF” messages designate the unit’s status, either enabled or disabled.
3. To change a unit’s status, press the **SAMPLE** key. Each press of the **SAMPLE** key will toggle the shown unit between “ON” and “OFF”.
4. To change to the next unit, press the **MODE** key.
5. Repeat steps 3 and 4 until all units have been programmed as desired.
6. Once the desired units have been enabled or disabled, save the configuration by pressing the **ZERO/CLEAR** key to resume normal operation.

User Configuration

All user parameters are embedded in a users menu consisting of 5 separate menu selections, each with its own sub-menu of choices. If your scale is connected by RS-232 serial communication lines to other equipment, or you wish to select the automatic power off period (battery option only), you may have to modify some or all of these parameters. To modify these parame-

ters, you must first enter the USER MENU mode.

Once there, four of the front panel keys become directional navigators to move around in the menus, and one key is used to save or SET the selections. Complete directions start below.

To place the unit in USER MENU mode:

- Turn the scale off.
- While holding down the **MR** key, turn the scale back on.
- When the display shows "**A1**", the unit is in USER MENU mode, and you can release the **MR** key. Shown at right are the directional and SET key assignments.

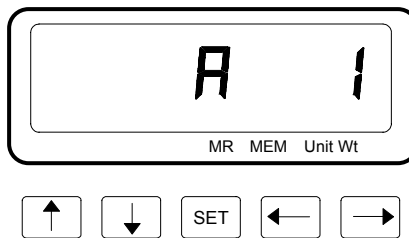

EL-3000 in User Menu Mode

USER MENU CHART

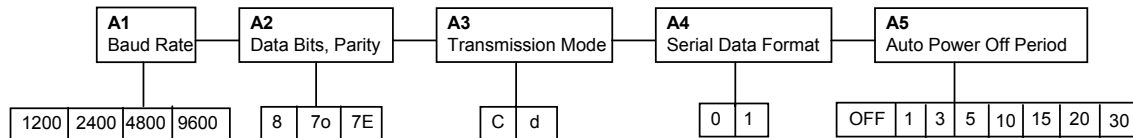

To place the unit back into the NORMAL OPERATING mode, turn off the power to the unit. With no keys held down, turn the power back on. All front panel keys will now return to their normal mode of operation.

User Menu Descriptions

NAME / CODE	DESCRIPTION	CODE / VALUE
A1 Baud Rate	Selects the baud rate for data transmission through the serial port.	1200 2400 4800 9600
A2 Data Bits and Parity	Selects the number of data bits and parity of serial transmission. "8" = 8 data bits with no parity bit "7O" = 7 data bits with odd parity bit "7E" = 7 data bits with even parity bit	8 7O 7E
A3 Mode of Serial Transmission	Selects when data will be sent out of the serial port to a printer or computer: "C" = Continuous mode; send data continuously "d" = Demand mode; send data when a PRINT command is issued from the printer, computer, or indicator.	C d
A4 Serial Data Format	Selects either full duplex mode or multi-item print mode. See Serial Data Format section for more information. "0" = Full Duplex Mode "1" = Multi-item (Simplex) Mode	0 1
A5 Auto Power Off Period	Selects the auto power off time in minutes. Scale must be idle during this period. "OFF" = Indicates this feature is disabled.	OFF, 1, 3, 5, 10, 15, 20, 30

Notes on A5 Auto Power Off Period:

1. Should be set to "OFF" if there is no internal battery.
2. The scale "chirps" three times with 30 seconds left, then "chirps" three times again with 3 seconds left before it shuts itself off.

Multi-Item Print

The EL-3000 comes standard with a feature called "Multi-item Print". This allows the user to have a printout of each weightment transaction plus the total. To enable this feature, select "1" for A4 in the User Menu and plug a serial printer into the DB-9 connector on the back of the scale. You may also need to alter the serial parameters A1 and A2 in order to match the printer's requirements.

Shown at right is an example of the multi-item print function. Each weightment is printed when the **M+** key is pressed. The total accumulated weight is printed when the **MR** key is pressed.

+	0.4405	LB
+	4.4075	LB
+	2.4435	LB
+	1.6595	LB
+	0.6470	LB
5T	9.5980	LB

Optional Battery Operation

Here are a few notes for those users who ordered the Battery Operation option for the EL-3000:

- ☑ Before using the scale for the first time, please charge the scale overnight.
- ☑ The scale's battery should operate for about 10 hours if left on continuously. Therefore, greater usage times can be achieved by selecting an appropriate Auto Power Off Period under **A5** of the User Menu.
- ☑ The scale can be charged while ON or OFF and can be operated while charging.

To charge the internal battery:

1. Connect the charger (AC Adapter 15 VDC, 800mA) to the scale , then plug the charger into an AC outlet.
2. After the charging period expires, unplug the charger from the AC outlet, then from the scale. The scale is now ready for use under its own battery power. If the scale is not allowed for charge for the full recommended time period, you may notice a decline in the usage period. This is due to the battery's reluctance to accept a charge. ***Therefore, always charge the scale for at least 10 hours before using.***
3. The charger may be left connected to the scale indefinitely without damage to the internal battery.

When to charge the internal battery:

1. When the scale needs to be charged, the Low Battery Indicator will appear in the lower right-hand corner of the display. The scale may be used for an additional 15 to 30 minutes without damage to the internal battery. ***If the scale is used for more than 30 minutes after a low battery indication, permanent damage may occur to the battery and/or the battery may not accept a charge.***
2. With the sealed lead-acid type battery, it is OK to charge the battery at any time to keep the battery "fresh". You do not necessarily have to wait for the Low Battery Indication.

NOTE: When a low battery indication occurs, the scale automatically shuts off after 5 minutes if the scale is idle. The period selected for Auto Power Off Period (A5) is not altered.

Calibration

The EL-3000 scale may be calibrated with any precision test weight from 10% to 100% of full scale capacity. If the scale was ordered in a avoirdupois configuration, the test weight unit must be in pounds. If the scale was ordered in a metric configuration, then the test weight unit must be in kilograms. The recommended test weight is about 2/3 of the full scale capacity, but in general, the larger the test weight, the more accurate the scale will be.

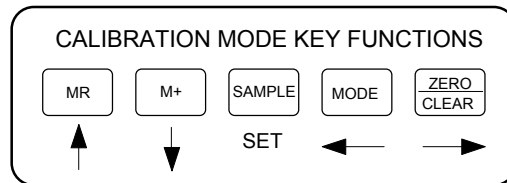

To calibrate the scale:

1. Turn the scale off. While pressing and holding down the **ZERO/CLEAR** key, turn the scale back on. The message "**C 0**" appears on the display briefly, followed by a value which remains on the screen. Allow a 20 minute warm-up period for the load cell and indicator to become thermally stable.
2. Press **ZERO/CLEAR** to zero the value, then press the **SAMPLE** key to save the zero point value.
3. The display will momentarily prompt "**C 1**" for the span calibration, followed by "**0.00**", "**0.000**", or "**0.0000**" depending on the scale capacity. The rightmost digit should be flashing. Place the test weight on the platform.
4. Use the four directional keys shown above to adjust the displayed value to the actual test weight value. Increase the flashing digit by pressing the **MR** key. Decrease the flashing digit by pressing the **M+** key. The position of the flashing digit may be changed by pressing the **ZERO/CLEAR** key or the **MODE** key.
5. After setting the exact value and letting the scale stabilize, press the **SAMPLE** key to save the value.
6. If the calibration was successful, the display will show "**ECAL**" then freeze. Exit the Calibration mode and enter the Normal Operating Mode by turning off the scale, then turning it back on with no keys held down.
7. If the calibration was *not* successful, one of the error messages below will appear. Take the indicated action to correct the problem, then perform a new calibration.

"Err0" - The calibration test weight or the adjusted keyed-in weight is larger than full scale. Change the calibration test weight or check the keyed-in weight.

"Err1" - The calibration test weight or the adjusted keyed-in weight is smaller than 10% of full scale. Change the calibration test weight or check the keyed-in weight.

"Err2" - Check keyed-in weight with the actual weight placed on platform.

Serial Data Formats

Full Duplex Overview:

The EL-3000 is equipped with a full duplex ASCII compatible RS-232C serial communications terminal wired as a DB-9 type connector mounted on the back of the scale. Full Duplex mode is enabled by selecting "0" for **A4** in the User Menu. The data format provides both Continuous and Demand serial transmission modes, selectable by **A3** in the User Menu.

The Continuous mode is used to interface to computers, scoreboards, and other remote devices requiring constant data updating. The transmission occurs at the end of each display update. Primarily designed to interface to printers, the Demand mode allows control from a host device, usually a PC, and can be activated by pressing the **MR** key on the front panel.

Full Duplex - Continuous Mode

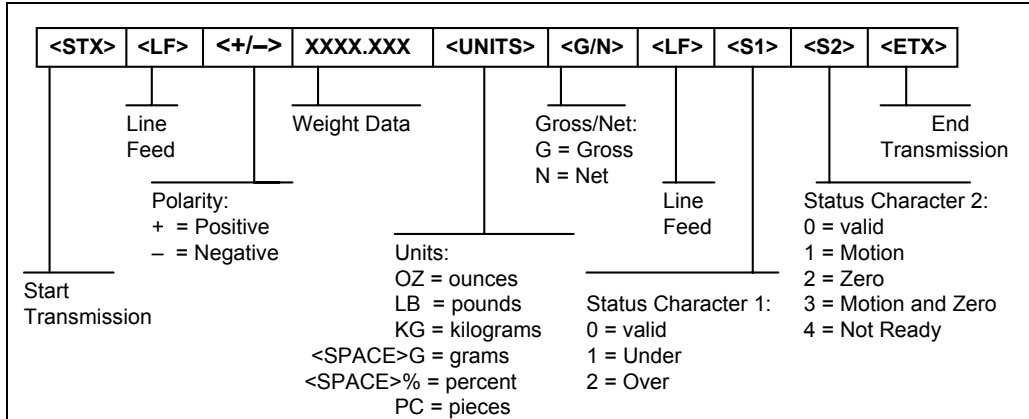

Transcell Technology Continuous Format

1. Recognized host command(s):
 "C" to change displayed units
 "Z" to zero the scale
2. Restrictions for transmission: No transmission during Display Check Mode
"Z" Command:
 Will not respond if the scale is in motion.

Serial Data Formats / Continued

Full Duplex - Demand Mode

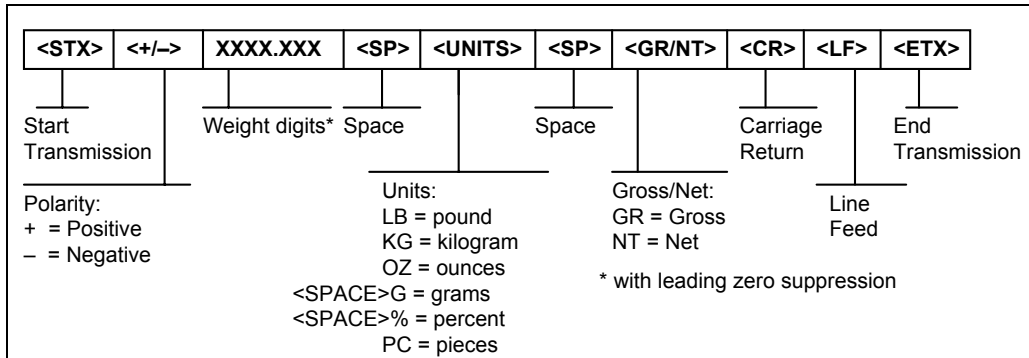

Transcell Technology Demand Mode - Valid Weight Reading

1. Recognized host command(s):

"P" for weight Data

"Z" to zero the scale

"C" to change displayed units

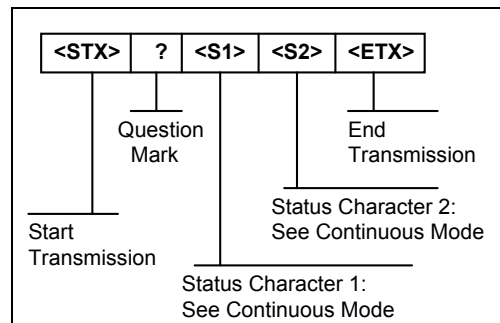

Transcell Technology Demand Mode - Invalid Weight Reading

2. Restrictions for transmission:

"P" Command:

Will send the "Invalid" format shown below if a) scale is not ready; b) scale is in motion; c) under zero; or d) over capacity.

"Z" Command:

Will not respond if the scale is in motion.

Specifications

CONSTRUCTION:

Housing: Ivory ABS
Base & Sub-Platform: Metal
Platform: Stainless Steel
Feet: Non-skid Hard Rubber

DISPLAY:

5½ Character, 7-Segment LCD

KEYPAD:

5-key Tactile Switch

OVER CAPACITY ANNUNCIATION:

103% of Full Scale Capacity

OPERATING TEMPERATURE RANGE:

32°F to 104°F
 (0°C to 40°C)

POWER SOURCE:

AC Adapter, 12 VDC, 500mA

OPTIONAL POWER SOURCE:

Internal 12 VDC, 1.2 Ah
 rechargeable lead acid battery.

Charger: AC Adapter, 15 VDC, 800mA

Charge Period: 8-10 hours

WEIGHT:

Net Weight: 8.8 lbs (4 kg)

Shipping Weight: 14.2 lb (6.4 kg)

Battery Option: Add 1.2 lb (0.5 kg)

SERIAL PORT:

Full Duplex RS-232 format

PHYSICAL DIMENSIONS:

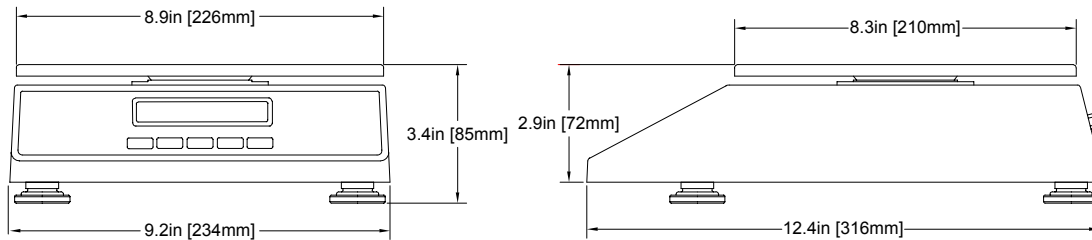

Displayed Error Messages

Display Message	Cause or Condition
□□□□□	Total weight on platform exceeds scale's capacity.
-----	During normal operation, the stainless steel platform was removed, resulting in an underrange condition. Replace scale platform.
-	Scale is negative during sample mode.

In Case of Trouble...

After reading your operating manual thoroughly, you should have no trouble using your scale. However, if you are still experiencing difficulty, please review the following points before calling or returning the scale.

PROBLEM	THINGS TO CHECK									
	A. 30 minute warm-up	B. Area vibrations	C. Air Currents	D. Ambient Temperature	E. Sub-platform	F. Magnetic Interference	G. AC Adapter	H. Line Voltage	I. Re-calibrate Scale	J. A/D or load cell
#1. Unstable Reading	X	X	X	X	X	X	X			X
#2. Does Not Weigh								X	X	
#3. No Display						X	X			

PROBLEM:

- When sample is placed on pan, display reading will not stabilize, i.e. jumps one or more divisions.
- Display will not change after sample is placed on platform or always shows overweight condition.
- No readout appears in the display window.

THINGS TO CHECK:

- Proper warm-up time is at least 30 minutes. It is recommended that the unit be left on continuously.
- Large machinery may cause vibration in the work area. The scale should be placed on a stable surface.
- Excessive air movement can affect stability. Scale should be located away from air conditioners, fans, fume hoods, etc. A breeze shield may be required.
- Extreme changes in room temperature can affect the internal calibration of the unit.

- The sub-platform is held in place by four screws which may vibrate loose. Remove the platform to check. **IMPORTANT: UNPLUG THE AC ADAPTER FROM THE AC OUTLET PRIOR TO REMOVING THE PLATFORM. Do not over tighten screws.**
- Do not place the scale near magnetic materials or instruments which incorporate magnets in their design.
- Replace AC Adapter. **IMPORTANT: Replace only with same voltage, current, and polarity of originally supplied adapter.**
- The line voltage to the scale should be reasonably constant and free from fluctuations. It is advisable not to share an outlet with fluorescent lights or other products which draw voltage in an inconsistent manner.
- Calibration memory has been lost. Re-calibrate scale.
- A/D converter is not stable or load cell has failed. Return scale for repair.

Warranty and Service Information

Seller warrants that the EL 3000 Counting Scale will conform to written specifications, drawings, and other descriptions made by the manufacturer, including any modifications thereof. The Seller warrants the goods against faulty workmanship and defective materials. If any goods fail to conform to these warranties, Seller will, as its sole and exclusive liability hereunder, repair or replace such goods if they are returned within the following warranty period:

Twelve (12) months from date of shipment from manufacturer.

These warranties are made upon the express condition that:

- 1) Transcell Technology, Inc. is given prompt written notice upon discovery by Buyer of such non-conformity, with a detailed explanation of the alleged deficiencies;
- 2) Such goods are returned to the Seller at the expense of the Buyer;
- 3) Examination of such goods by Seller discloses that the nonconformity actually exists and was not caused by accident, misuse, neglect, alteration, improper installation improper or unauthorized repair, or improper testing, and
- 4) Such goods have not been modified, altered, or changed by any person other than the Seller or its duly authorized repair agents.
- 5) Transcell Technology, Inc. will have a reasonable time to repair or replace such goods.

THESE WARRANTIES EXCLUDE ALL OTHER WARRANTIES, EXPRESS OR IMPLIED, ORAL OR WRITTEN, INCLUDING WITHOUT LIMITATION WARRANTIES OF MERCHANTABILITY OR FITNESS FOR A PARTICULAR PURPOSE. SELLER WILL NOT IN ANY EVENT BE LIABLE FOR INCIDENTAL OR CONSEQUENTIAL DAMAGES.

IN ACCEPTING THIS WARRANTY, THE PURCHASER OR BUYER AGREES TO WAIVE ANY AND ALL OTHER CLAIMS FOR RIGHT TO WARRANTY FROM TRANSCCELL TECHNOLOGY, INC. SHOULD THE SELLER BE OTHER THAN TRANSCCELL TECHNOLOGY, INC., THE BUYER AGREES TO LOOK ONLY TO THE SELLER FOR WARRANTY CLAIM OR CLAIMS.

No terms, conditions, understanding, or agreements purporting to modify the terms of this warranty shall have any legal effect unless made in writing and signed by a corporate officer of the Seller.