

EL5000 Series

Digital Balance

Operation Manual

Revision 1.1
July 22, 1999

Transcell Technology inc.

© 1999 Transcell Technology, Inc.

Contents subject to change without notice.

Transcell Technology, Inc.
975 Deerfield Parkway
Buffalo Grove, IL 60089
Tel (847) 419-9180
Fax (847) 419-1515

NOTE

This equipment has been tested and found to comply with the limits for a Class A digital device, pursuant to Part 15 of the FCC Rules. These limits are designed to provide reasonable protection against harmful interference when the equipment is operated in a commercial environment. This equipment generates, uses and can radiate radio frequency energy and, if not installed and used in accordance with the instructions manual, may cause harmful interference to radio communications. Operation of this equipment in a residential area is likely to cause harmful interference in which case the user will be required to correct the interference at his/her own expense.

TABLE OF CONTENTS

	<u>Page</u>
Chapter 1: Introduction to the Transcell EL5000 Series Digital Balance.....	1-1
Chapter 2: Getting Started	2-1
Chapter 3: Operation.....	3-1
3.1 Display	3-1
3.1.1 Liquid Crystal Display (LCD).....	3-1
3.2 Keyboard	3-2
3.2.1 Function Keys	3-2
3.3 General Scale Operation	3-2
3.3.1 Weighing an Item.....	3-2
3.3.2 Taring an Item.....	3-3
3.3.3 Clearing a Tare	3-3
Chapter 4: Advanced Features and Operation.....	4-1
4.1 Piece Counting	4-1
4.2 Clearing the Piece Count	4-1
4.3 Memory Accumulator.....	4-1
4.3.1 Displaying the Memory Accumulator	4-2
4.3.2 Adding to the Memory Accumulator.....	4-2
4.3.3 Clearing the Memory Accumulator	4-2
4.4 Percentage Mode	4-2
Chapter 5: Scale Configuration	5-1
5.1 Scale Configuration Overview	5-1
5.2 User (“A”) Menu	5-1
5.2.1 Entering the User Menu.....	5-1
5.2.2 Navigating in the User Menu	5-1
5.2.3 Notes on the User Menu.....	5-2
5.2.4 Units Selection Procedure (A6)	5-3
5.2.5 Custom Unit Procedure (A7).....	5-3
5.2.6 Exiting the User Menu.....	5-3
5.2 Factory Setup (“F”) Menu.....	5-3
Chapter 6: Scale Calibration	6-1
6.1 Scale Calibration Overview.....	6-1
6.2 Scale Calibration Procedure	6-1

Appendix A: Specifications	A-1
Appendix B: Serial Port Information.....	B-1
B.1 Serial Port Hardware.....	B-1
B.2 Serial Port Modes.....	B-1
B.2.1 Demand Mode.....	B-1
B.2.2 Continuous Mode	B-3
B.2.3 Recognized Host Commands	B-4
Appendix C: Error Messages.....	C-1
C.1 Error Messages.....	C-1
C.1.1 Operator Errors	C-1

LIST OF FIGURES

1-1 EL5000 Series Front Panel	1-1
2-1 EL5000 Back Panel.....	2-1
3-1 EL5000 Display Detail.....	3-1
3-2 Function Keys Layout.....	3-2
5-1 User Menu Key Assignments.....	5-1
5-2 User Menu Chart.....	5-2
6-1 Calibration Mode Key Assignments	6-1
B-1 Pin Assignments for DSUB9 serial port connector	B-1
B-2 Cable Diagram for Scale to PC	B-1
B-3 Cable Diagram for Scale to Printer.....	B-1
B-4 Demand Mode Output Format for Print Command	B-2
B-5 Demand Mode Output Format for M+ Command	B-2
B-6 Demand Mode Output Format for MR Command	B-3
B-7 Continuous Mode Output Format	B-4

LIST OF TABLES

1-1 EL5000 Series Product Matrix.....	1-1
3-1 EL5000 Series Annunciator Definitions.....	3-1
4-1 EL5000 Piece Counting Sampling Limits.....	4-1
4-2 EL5000 Percentage Sampling Limits.....	4-2
5-1 User Menu Chart.....	5-2

CHAPTER 1: INTRODUCTION TO THE TRANSCCELL EL5000 SERIES DIGITAL BALANCE

The EL-5000 Series Digital Balance, available in several capacities, is an easy to use, high resolution counting scale featuring several weighing units, battery power, multi-item print function, and a weight accumulator. All scales calibrate with metric (gram) weights. The standard weighing units include gram, carat, avoirdupois pound, avoirdupois ounce, grain, troy ounce and pennyweight. In addition, you may program one additional custom unit.

The scale is available in two weight capacities as illustrated in Table 1-1.

Prior to using the scale, please read this user's guide carefully and completely. Store the manual in a safe and convenient place so it will be available if you have questions concerning the operation of the scale.

MODEL	EL-5150	EL-5300
Gram (g)	1500 x 0.05	3000 x 0.1
Carat (ct)	7500 x 0.2	15000 x 0.5
Avoir Pound (lb)	3x 0.0001	6x 0.0002
Avoir Ounce (oz)	50 x 0.002	100 x 0.005
Grain (GN)	23000 x 1	46000 x 2
Troy Ounce (ozt)	48 x 0.002	96 x 0.005
Pennyweight (dwt)	965 x 0.05	1930 x 0.1

Table 1-1: EL5000 Series Product Matrix

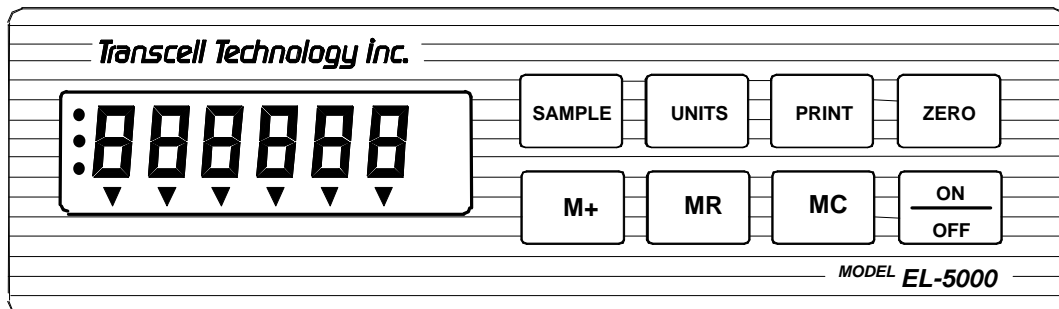

Figure 1-1: EL5000 Series Front Panel

CHAPTER 2: GETTING STARTED

After unpacking the scale, a small amount of preparation is required before the scale can be used. Please refer to Figure 2-1 below as needed.

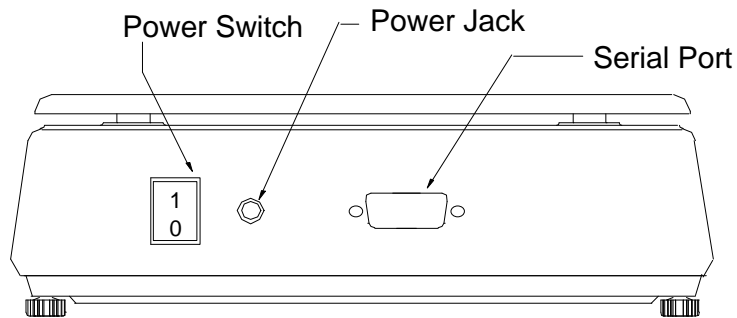

Figure 2-1: EL5000 Back Panel

- Step 1. Position the scale in its area of intended use. Observe the following guidelines for suitable location.
1. Choose a firm, stable floor or table.
 2. Do not share an AC outlet with electrical noise producing equipment, such as refrigeration units. This includes products with electrical motors and/or relays.
 3. Do not place the scale in an area with changing ambient temperature and/or high humidity.
 4. Do not place the scale in an area prone to exposure to direct sunlight, wind, or dust.
 5. Do not place the scale in an area with vibrating equipment.
- Step 2. Install the AC Adapter.
1. After placing the scale in its area of use, locate the Model MCS950 AC Adapter.
 2. Connect the female end of the AC Adapter to the connector on the rear of scale, and then plug the adapter into an AC outlet.
- Step 3. If applicable, install the serial printer.
1. Connect the printer to the EL5000's interface port using the optional serial cable.
 2. Configure the printer's communication parameters as detailed in Chapter 5.
- Step 4. Turn the scale's AC power on to begin use.

NOTE: Six AA size alkaline batteries may also be used to power the scale. The battery holder is located underneath the scale. Please observe the indicated polarity when installing the batteries.

CHAPTER 3: OPERATION

3.1 DISPLAY

The Model EL5000 series scale utilizes a 6 character LCD (Liquid Crystal Display) to display the weight and system information.

3.1.1 LIQUID CRYSTAL DISPLAY (LCD)

Figure 3-1 shows the display detail of the EL5000 Series. The display consists of 6 numeric characters, weight units and system status flags. Table 3-1 lists the various annunciators you may see and their meanings.

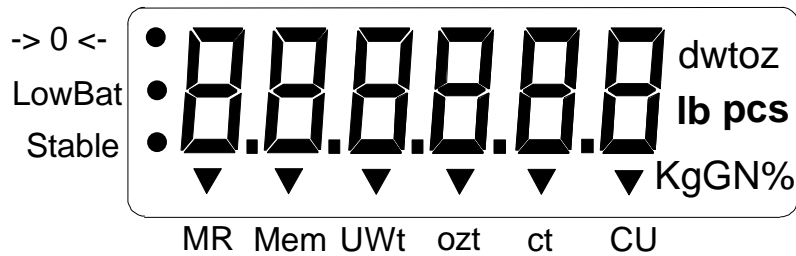

FIGURE 3-1: EL5000 Display Detail

Annunciator	MEANING
-> 0 <-	Center of Zero annunciator. Indicates that the scale is at gross zero.
LowBat	Indicates a low battery condition. Check / replace the batteries.
Stable	This light is on whenever the scale is stable.
MR	Indicates that the scale is briefly displaying the contents of the memory accumulator.
Mem	Indicates that there is a value greater than zero in the memory accumulator.
Uwt	Indicates that the scale is displaying the APW (Average Piece Weight) in grams of the items you are counting.
ozt	Indicates that the scale is currently weighing in troy ounces.
ct	Indicates that the scale is currently weighing in carats.
CU	Indicates that the scale is currently weighing in your programmed custom unit.
dwt, oz, lb, g, GN	Indicates the unit of measure the scale is currently weighing in.
pcs, %	Indicates that the scale is currently in piece count or percentage mode.

TABLE 3-1: EL5000 Series Annunciator Definitions

3.2 KEYBOARD

The keyboard is composed of eight function keys. Refer to Figure 3-2 for the overall layout and key locations.

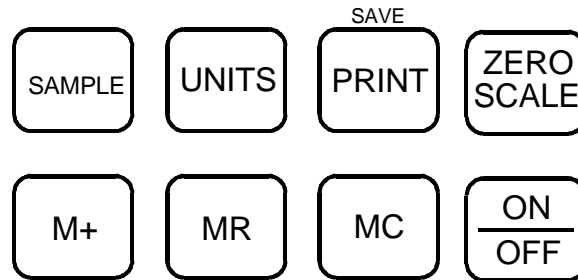

FIGURE 3-2: Function Keys Layout

3.2.1 FUNCTION KEYS

Zero - This key sets the scale to display zero.

Sample – This key puts the scale into sampling mode, which is used for piece counting. See Section 4.1 for more information.

Units – This key toggles the scale among the available weight units. Available weight units include lb, oz, g, pieces, %, GN, dwt, ct, ozt, and custom unit.

M+ – Pressing this key adds the displayed weight or pieces to the memory accumulator. See Section 4.3 for more information.

MR – Pressing this key briefly displays the contents of the memory accumulator. See Section 4.3 for more information.

MC – Pressing this key clears the memory accumulator. Section 4.3 for more information.

Print - This key is used to send weight information out to the serial interface port. The scale cannot be in motion or in an overload condition.

On/Off - This key toggles the scale ON and OFF.

3.3 GENERAL SCALE OPERATION

3.3.1 WEIGHING AN ITEM

1. Select the desired weighing unit by pressing the UNITS key until that unit is indicated on the display.
2. If necessary, press the ZERO key to obtain a weight reading of zero.
3. Place the object to be weighed on the scale's platter and allow the weight indication to stabilize. If the item weight exceeds the scale's weight capacity, it displays "ooooo".
4. Read the weight shown on the display.

3.3.2 TARING AN ITEM

To weigh an item in a container, the weight of that container must first be subtracted from the overall weight to obtain an accurate weight reading. This is known as taring.

1. Select the desired weighing unit by pressing the UNITS key until that unit is indicated on the display.
2. Place the empty container on the scale's platter and allow the weight indication to stabilize.
3. Press the ZERO key.
4. Place the material to be weighed in the container and allow the weight indication to stabilize.
5. Read the weight shown on the display.

3.3.3 CLEARING A TARE

1. To clear a tare, take everything off of the scale's platter and press the ZERO key.

CHAPTER 4: ADVANCED FEATURES AND OPERATION

4.1 PIECE COUNTING

This mode is used to indicate the number of pieces of an item you have placed on the scale's platform and is accessed by pressing the SAMPLE key. To ensure accuracy, the parts you are counting must be consistent in weight.

The scale uses the sampling method to determine the average piece weight (APW) of the items you wish to count. When sampling items, always count the parts in your hand and place them on the platform all at once. If the APW of the items is too light or the total weight of the sample is too light, accuracy cannot be guaranteed. You will get an error message, but piece counting will still be allowed. Consult Table 4-1 for minimum piece weights and sample weights.

1. If the items you will be counting require a container, you must first tare the container off by pressing the ZERO key.
2. Press the SAMPLE key. The scale will display "10 0 pcs". The scale is prompting you to place ten identical items on the platform.

NOTE: If you wish to change the sample number, simply press the SAMPLE key repeatedly until the desired sample number appears. Available choices are 10, 20, 50, 100, 200, and 500.

3. Place the sample items on the platform all at once. Once the scale stabilizes, the scale will display "10 – pcs".
4. Press the SAMPLE key to take the sample. If the sample meets the limits shown in Table 4-1, the scale will now display the number of pieces on the scale. If it does not, the scale briefly displays an "Lo", but still allows piece counting. If this occurs, you should use a higher sample amount to achieve better piece count accuracy.

NOTE: If the scale displays an "Add" message, the unit weight of the items you wish to count or total sample weight is too light for your scale to process at all.

MODEL	Capacity / Graduation	Minimum Piece Weight	Minimum Sample Weight
EL-5150	1500 x 0.05 g	0.04 g	1.25 g
EL-5300	30000 x 0.1 g	0.08 g	2.5 g

TABLE 4-1: EL5000 Piece Counting Sampling Limits

4.2 CLEARING THE PIECE COUNT

1. To clear the piece count, press the SAMPLE key to take a new sample.

4.3 MEMORY ACCUMULATOR

Your scale comes equipped with a handy memory accumulator, which can be used in conjunction with the piece counting feature. As with a hand-held calculator, the memory accumulator can be added to, displayed and cleared at anytime.

NOTE: This feature can be used in any weighing mode. However, the accumulator memory is automatically cleared if the scale is switched to another unit of measure using the UNITS key.

4.3.1 DISPLAYING THE MEMORY ACCUMULATOR

1. Press the MR key. The scale briefly displays the total value stored in the accumulator.

NOTE: If a device is connected to the scale's serial port, then that device will receive an automatic printout of the number of entries made and as well as the total value stored in the accumulator. See Appendix B for more detailed information.

4.3.2 ADDING TO THE MEMORY ACCUMULATOR

1. Press the M+ key. The scale adds the current value shown on the display to the memory accumulator.

NOTE: If a device is connected to the scale's serial port, then that device will receive an automatic printout of that entry. See Appendix B for more detailed information.

4.3.3 CLEARING THE MEMORY ACCUMULATOR

1. Press the MC key. The scale displays "Clr" to indicate that the memory has been cleared.

4.4 PERCENTAGE MODE

This mode is used to indicate the weight percentage of an item you have placed on the scale's platform relative to 100%. This is useful for filling and moisture determination applications.

The scale uses the sampling method to determine the percentage value of 100%. Consult Table 4-2 for acceptance criteria.

1. Press the UNITS key until the scale is in percentage mode, indicated by the % sign. The scale should display "100 0 %". If it does not, press the SAMPLE key.
2. If the items you will be counting require a container, you must first tare the container off by pressing the ZERO key.
3. Place the reference item (100%) on the platform. Once the scale stabilizes, the scale will display "100 - %".
4. Press the SAMPLE key to take the sample. If the sample meets the limits shown in Table 4-2, the scale will now display 100%.

NOTE: If the scale displays a "Add" message, the weight of the reference item you wish to sample is too light for your scale to process at all.

MODEL	Capacity / Graduation	Minimum Sample Weight	Best Sample Weight
EL-5150	1500 x 0.05 g	5 g	500 g
EL-5300	30000 x 0.1 g	10 g	1000 g

TABLE 4-2: EL5000 Percentage Sampling Limits

CHAPTER 5: SCALE CONFIGURATION

5.1 SCALE CONFIGURATION OVERVIEW

The scale contains two main setup menus: The User (“A”) menu - which configures the serial communication port and enables some user options - and the Factory Setup (“F”) menu. Both menus consist of several menu selections, each with its own sub-menu of choices.

5.2 USER (“A”) MENU

5.2.1 ENTERING THE USER MENU

1. Turn OFF the scale.
2. Press and hold the UNITS key while turning the scale back ON.
3. When the scale shows “- - - - -”, you may release the UNITS key. The scale shows “A 1”.

5.2.2 NAVIGATING IN THE USER MENU

Use the directional keys shown in Figure 5-1 to move around in the User Menu Chart shown in Figure 5-2 on the following page.

1. To move to a new “A” heading, use the M+ (left) or MR (right) key to move right or left in the User Menu Chart.
2. To move to the selection level, press the UNITS (down) key once. The current saved selection is shown.
3. To view the available selections for the current “A” heading, use the M+ (left) or MR (right) key to move through the selection field.
4. To save a new selection, press the PRINT (Save) key. To exit without saving, press the SAMPLE (up) key to return to the current “A” heading.
5. Repeat Steps 2 through 5 until the User Menu is programmed.

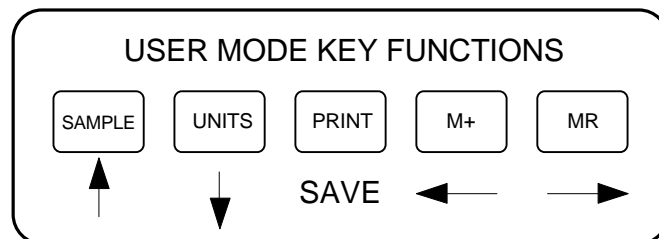

Figure 5-1: User Menu Key Assignments

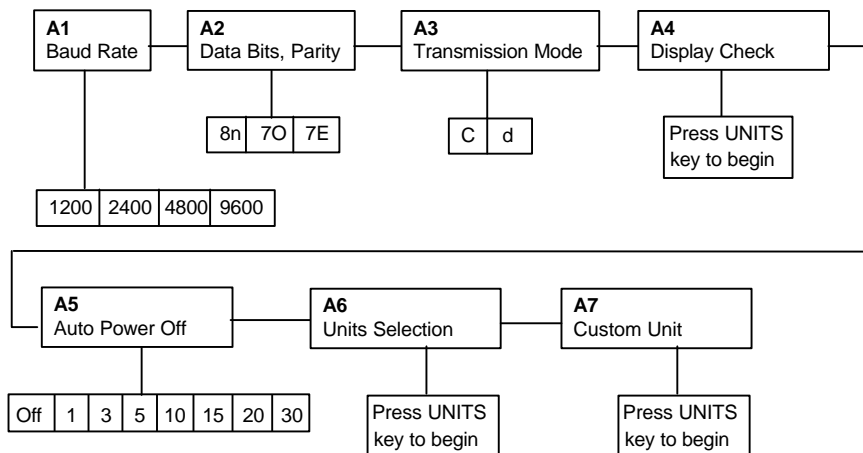

Figure 5-2: User Menu Chart

5.2.3 NOTES ON THE USER MENU

1. Detailed descriptions of the user menu parameters can be found in Table 5-1 below. Factory-set defaults are shown in bold with a checkmark (✓).

NAME/CODE	DESCRIPTION	CODE/VALUE
A1 Baud Rate	Selects the baud rate for data transmission through the serial port.	1200 2400 ✓ 4800 9600
A2 Data Bits and Parity	Selects the number of data bits and parity of serial transmission. "8n" = 8 data bits with no parity bit and one stop bit "7O" = 7 data bits with odd parity bit and one stop bit "7E" = 7 data bits with even parity bit and one stop bit	8n ✓ 7O 7E
A3 Mode of Serial Transmission	Selects when data will be sent out of the serial port to a printer or computer: "C" = Continuous mode; send data continuously "d" = Demand mode; send data when a PRINT command is issued from the computer.	C d ✓
A4 Display Check	Actuates the function that illuminates all digit segments, decimal points, and LCD annunciators in a test sequence. Pressing the UNITS key to scroll down one level begins the test sequence.	Press UNITS key to begin sequence
A5 Auto Power Off Period	Selects the auto off time period in minutes. Scale must be idle during this period to shut off automatically. "OFF" = Feature Disabled	OFF ✓ 3 5 10 20 30
A6 Units Selection	Actuates the function that allows customization of the displayed weight units. Pressing the UNITS key to scroll down one level begins the sequence.	Press UNITS key to begin sequence
A7 Custom Unit	Actuates the function that allows setup of the custom unit. Pressing the UNITS key to scroll down one level begins the sequence.	Press UNITS key to begin sequence

Table 5-1: User Menu Chart

5.2.4 UNITS SELECTION PROCEDURE (A6)

1. While in the A6.sub-menu, press the UNITS key. The scale displays "Unit" briefly, then illuminates the carat annunciator and displays the current status (ON or OFF) of the carat unit.
2. Use the M+ key to toggle the status of the unit to the one desired.
3. Use the SAMPLE key to toggle among the available weight units.
4. Repeat Steps #2 and #3 until you have programmed all units.
5. Press the PRINT key to save all of your new settings and return back to the A6 sub-menu prompt.

5.2.5 CUSTOM UNIT PROCEDURE (A7)

The custom unit multiplier is the conversion factor that you would multiply grams by in order to obtain the custom unit of weight. For example, if you wish to display weight in troy ounces, you would enter in a multiplier value of 0.64301 (1 g = 0.64301 ozt). The scale automatically determines the proper display increment for your custom unit.

1. While in the User Menu, scroll to "A 7", then scroll down once using the UNITS key to enter the custom unit multiplier menu.
2. The display will momentarily show "C U" for the custom unit, followed by the current value for the custom unit multiplier with the decimal point.
3. Use the left or right directional keys (shown in Figure 5-1 above) to move the decimal point position to the correct position. Pressing the M+ key or the MR key will change the position of the decimal point.
4. After setting the correct decimal point position, press the PRINT key to save it.
5. The display will momentarily show "SET", followed by a value with one flashing digit. This value will be the current multiplier value with the decimal point position programmed above.
6. Use the four directional keys (shown in Figure 5-1 above) to adjust the displayed value to the actual custom unit multiplier value. Increase the flashing digit by pressing the SAMPLE key. Decrease the flashing digit by pressing the UNITS key. Pressing the M+ key or the MR key will change the position of the flashing digit.
7. After setting the exact value, press the PRINT key to save the custom unit multiplier value. The display will show "EndCU" momentarily, then revert back up to A7.

5.2.6 EXITING THE USER MENU

1. Exit the User ("A") menu by first turning the scale OFF, then turning it back ON without holding down any keys. The display will go through a digit check, then settle into Normal Operating mode. All front panel keys will now return to their normal mode of operation.

5.2 FACTORY SETUP ("F") MENU

This menu is covered in a separate service document.

CHAPTER 6: SCALE CALIBRATION

6.1 SCALE CALIBRATION OVERVIEW

The EL-5000 scale may be calibrated with any precision test weight from 10% to 100% of full-scale capacity. The test weight unit must be in grams. The recommended test weight is about 2/3 of the full-scale capacity, but in general, the larger the test weight, the more accurate the scale will be.

6.2 SCALE CALIBRATION PROCEDURE

1. Turn the scale off. While pressing and holding down the ZERO key, turn the scale back ON.
2. When the scale shows "-----", you may release the ZERO key.
3. The message "C 0" appears on the display briefly, followed by a value which remains on the screen. Allow a 20 minute warm-up period for the load cell and indicator to become thermally stable.
4. Press ZERO to zero the value. The scale shows "Zero" for a few seconds to indicate that it has acknowledged the key press.
5. Press the PRINT key to save the zero point value. The scale shows "Save" for a few seconds to indicate that it has acknowledged the key press, followed by "Set".
6. The display will momentarily prompt "C 1" for the span calibration, followed by "0.0" or "0.00" depending on the scale capacity. The rightmost digit should be flashing
7. Use the four directional keys shown in Figure 6-1 to adjust the displayed value to the actual test weight value. Increase the flashing digit by pressing the SAMPLE key. Decrease the flashing digit by pressing the UNITS key. The position of the flashing digit may be changed by pressing the M+ key or the MR key.

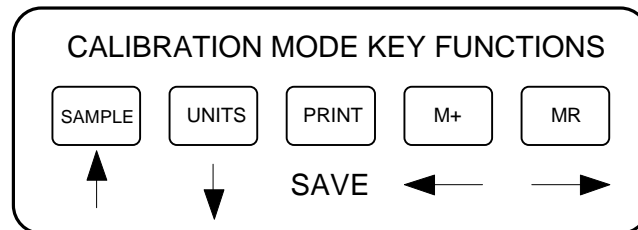

Figure 6-1: Calibration Mode Key Assignments

8. After setting the exact value, place the test weight on the platform and press the PRINT key to save the value. The scale shows "Save" for a few seconds to indicate that it has acknowledged the key press.
9. If the calibration was successful, the display will show "SET" then automatically return to Normal Operating Mode. Remove the test weight before the scale completes its countdown.
10. If the calibration was *not* successful, one of the error messages below will appear. Take the indicated action to correct the problem, then perform a new calibration.
 - "Err0" - The calibration test weight or the adjusted keyed-in weight is larger than full scale. Change the calibration test weight or check the keyed-in weight.
 - "Err1" - The calibration test weight or the adjusted keyed-in weight is smaller than 10% of full scale. Change the calibration test weight or check the keyed-in weight.
 - "Err2" - Check keyed-in weight with the actual weight placed on platform.

APPENDIX A: SPECIFICATIONS

CONSTRUCTION:

Housings: Ivory ABS
Sub-Platform: Metal
Platter: Plastic with Stainless Steel Cover
Feet: Adjustable Non-skid Hard Rubber

DISPLAY:

6 digit, 7-segment LCD

KEYPAD:

8-key Tactile Keypad

OVER CAPACITY ANNUNCIATION:

103% of Full Scale Capacity

OPERATING TEMPERATURE RANGE:

32°F to 104°F
(0°C to 40°C)

POWER SOURCE:

AC Adapter, 9VDC, 500 mA,
included

ALTERNATIVE POWER SOURCE:

6-AA alkaline batteries, replaceable

SERIAL PORT:

Full Duplex RS-232,
Female DSUB9

WEIGHT:

Net Weight: 3.0 lb (1.4 kg)
Shipping Weight: 4.8 lb (2.2 kg)

PHYSICAL DIMENSIONS:

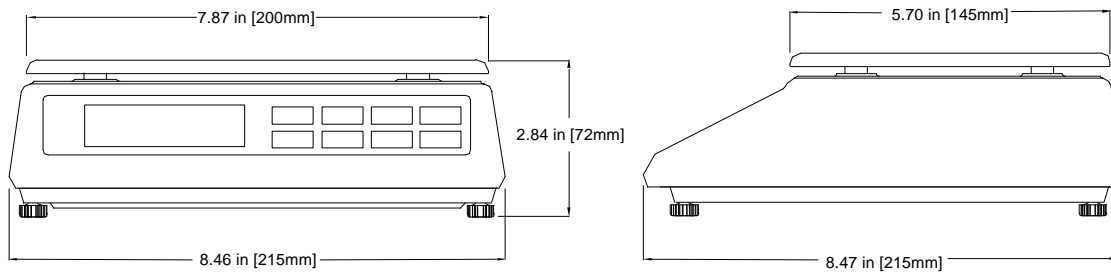

APPENDIX B: SERIAL PORT INFORMATION

B.1 SERIAL PORT HARDWARE

The EL5000 series scale comes standard with a full duplex, RS-232 port designed for connection to a PC, scoreboard or serial printer. Figure B-1 shows the serial port pin assignments for the scale's female DSUB9 connector. Refer to Figures B-2 and B-3 for some suggested cable diagrams.

1. Plug the serial printer or computer communication cable (not included) directly into the scale's DSUB9 serial port connector.

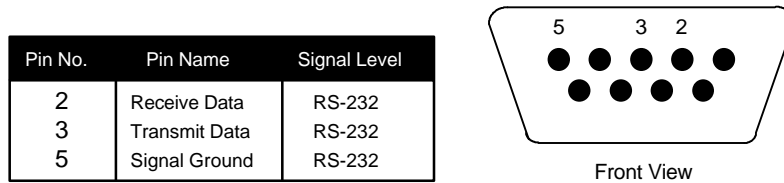

Figure B-1: Pin assignments for the DSUB9 serial port connector

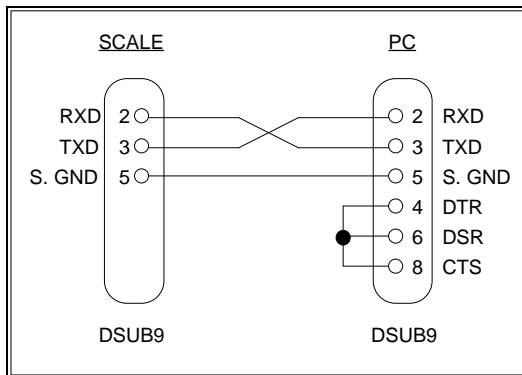

FIGURE B-2. Cable Diagram for Scale to PC

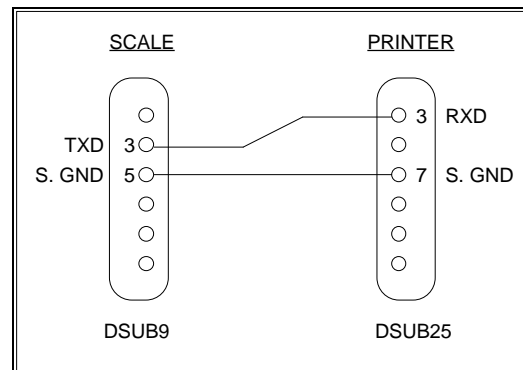

FIGURE B-3. Cable Diagram for Scale to Printer

B.2 SERIAL PORT MODES

B.2.1 DEMAND MODE

The scale provides a full duplex, demand serial transmission mode. This mode is configured in the A3 sub-menu of the User Menu. See Chapter 5 for more information. The demand mode allows control from a host device, such as a PC, and can also be activated by pressing the PRINT key on the scale's front panel. Figure B-2 shows a suggested cable diagram for interface to a PC.

Demand mode is also used when interfacing to a serial printer. Figure B-3 shows a suggested cable diagram for interface to a serial printer.

Figure B-4 shows the serial output data format for demand mode when a PRINT command is issued to the scale.

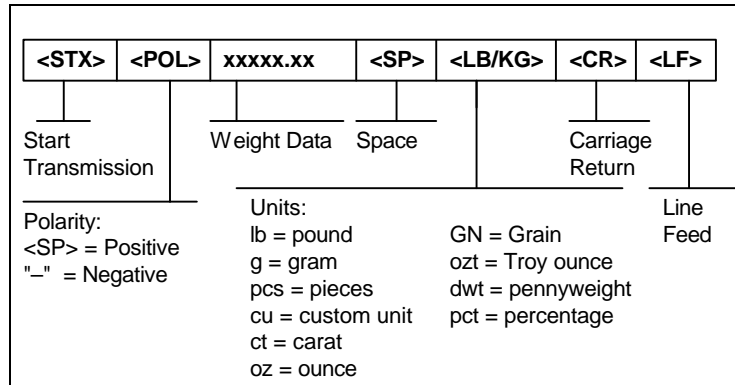

FIGURE B-4. Demand Mode Output Format for Print Command

Figure B-5 shows the serial output data format for demand mode when an M+ (Memory Plus) command is issued to the scale.

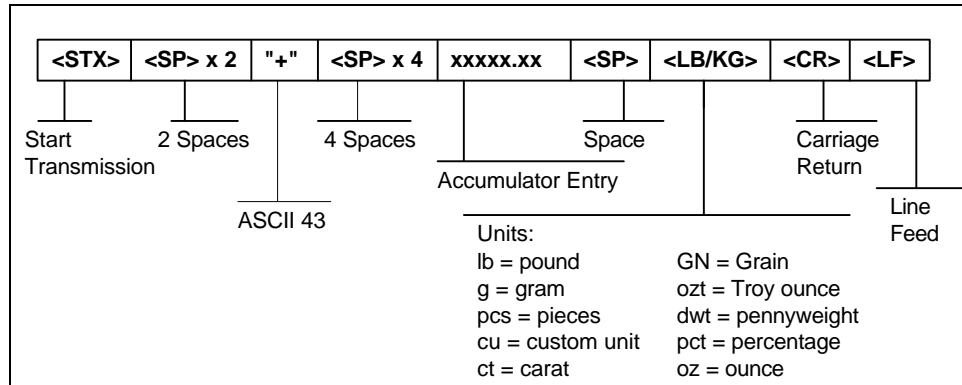

FIGURE B-5. Demand Mode Output Format for M+ Command

Figure B-6 shows the serial output data format for demand mode when an MR (Memory Recall) command is issued to the scale.

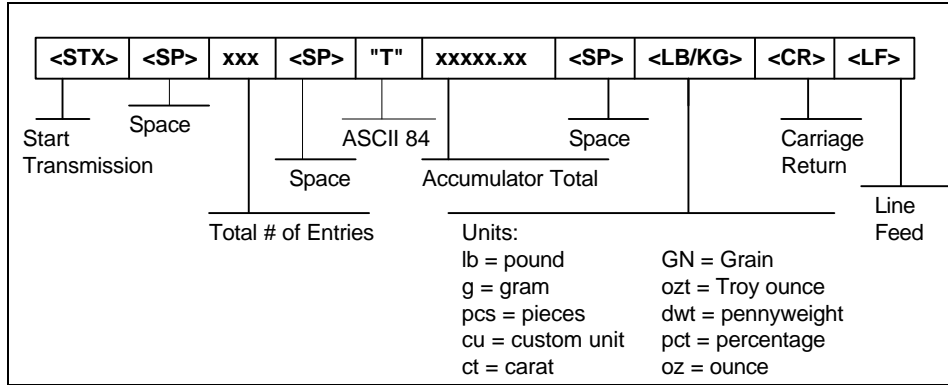

FIGURE B-6. Demand Mode Output Format for MR Command

B.2.2 CONTINUOUS MODE

The scale provides a full duplex, continuous serial transmission mode. This mode is configured in the A3 sub-menu of the User Menu. See Chapter 5 for more information. The continuous mode is used to interface to computers, scoreboards, and other remote devices requiring constant data updating. The transmission occurs at the end of each display update. Figure B-7 shows the serial data format for Continuous Mode.

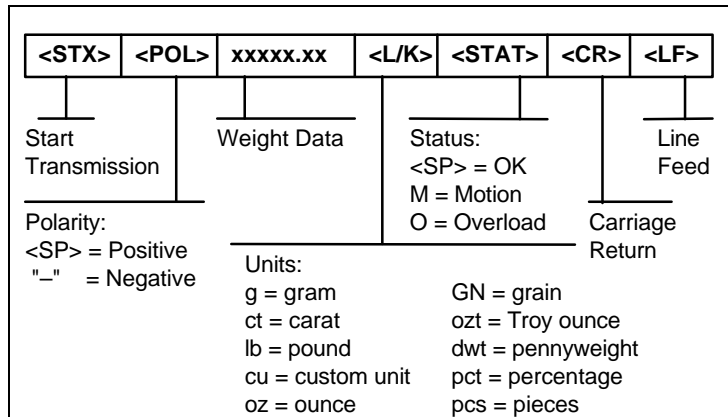

FIGURE B-7. Continuous Mode Output Format

B.2.3 RECOGNIZED HOST COMMANDS

“P” - This command is sent to the scale to print the indicated display. The scale will not respond if the scale is in motion, positive overload or negative overload.

“Z” - This command is sent to the scale to zero the scale. The scale will not respond if the scale is in motion, positive overload or negative overload.

“M” - This command is sent to the scale to add an entry to the accumulator (M+).

“R” - This command is sent to the scale to recall the contents of the accumulator (MR).

“C” - This command is sent to the scale to clear the contents of the accumulator (MC).

“U” - This command is sent to the scale to toggle among the configured units.

APPENDIX C: ERROR MESSAGES

C.1 ERROR MESSAGES

If the scale encounters an error condition, it will display a message alerting the operator. A description of each display follows:

C.1.1 OPERATOR ERRORS

Message	Explanation
"o o o o o o"	Indicates that the weighing capacity of the scale has been exceeded.
<i>Add</i>	Indicates that there is not enough internal resolution to calculate the unit weight of an item. This means that the items you are counting are too light for the scale to process at all.
<i>Lo</i>	Indicates that unit weight of the items you are sampling is too light for the scale to process accurately.
<i>O L</i>	Indicates that value in the accumulator exceeds the display capacity of the scale.
<i>Err 10</i>	Scale cannot read serial number. Scale must be returned for service.
<i>Err 11</i>	Serial number mismatch. Re-enter setting code from product ID tag.
<i>Err 12</i>	Invalid setting code. Re-enter proper setting code from product ID tag.

Note: Contact Service Department at Transcell for instructions on how to re-enter setting code.