

## Pancake Type

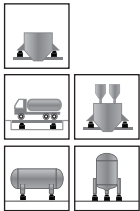
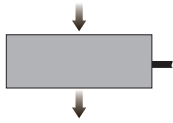

### Capacities

200t

### Features

- Pancake type load cell
- Alloy steel construction
- High accuracy
- High stability
- Low profile
- Easy to install
- Protected against corrosion by nickel-plated treatment
- Suitable for testing machine, truck scales and big bin & hopper scales, etc.

### Schematic

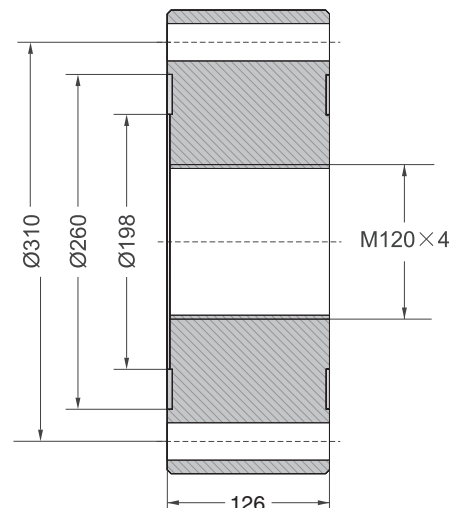
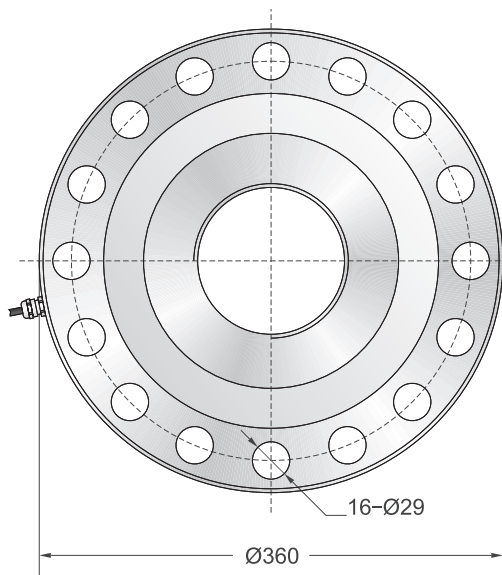
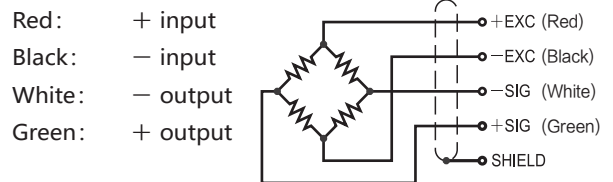

Specifications			
Rated Output	2.0mV/V ±0.25%	Safe Temp. Range	-10°C to + 70°C
Zero Balance	±1% of rated output	Temp. Compensated	-10°C to + 40°C
Creep after 30 minutes	±0.5% of rated output	Safe Overload	150%
Nonlinearity	±0.5% of rated output	Input Impedance	775 ohm ± 20 ohm
Hysteresis	±0.5% of rated output	Output Impedance	700 ohm ± 5 ohm
Repeatability	±0.5% of rated output	Insulation Resistance	≥5000 M ohm (50V DC)
Temp. effect on output	≤0.002% of applied output/°C	Rated Excitation	10V DC/AC
Temp. effect on zero	≤0.002% of rated output/°C	Maximum Excitation	15V DC/AC
Wire Length	6m	Wire Material	Red(+E) Black(-E) White(-S) Green(+S)